



# Rainwater Goods PRICE LIST

## NSW & ACT



Quality Guttering Since 1953

Manufactured from



APRIL 2018



# Our Commitment to Customer Service

We are fully committed to meeting the needs of our customers by providing quality products, reliable service and value for money.

## AT ACE GUTTERS WE VALUE:

### Honesty and Integrity:

Being ethical in our relationship with customers, suppliers and staff.

### Mutual Respect:

Building solid working relationships through trust, teamwork and faith in each others ability.

### Acceptance of Change:

The ability to adapt and evolve with the changing market place through product innovation, manufacturing techniques and technological advancements.

For over 60 years Ace Gutters has maintained a reputation as a manufacturer of the highest quality rainwater goods, offering complete systems of guttering and drainage.



# ACE GUTTERS PTY LTD

69 Boundary Road Mortdale NSW 2223

PO Box 99 Mortdale NSW 2223

Phone: (02) 9584 4777 Fax Orders: (02) 9584 4799

Fax Accounts: (02) 9584 4733

Email: sales@acegutters.com.au

## TRADING HOURS

Weekdays 6am – 4.15pm  
Saturdays 7am – 11am

## OFFICE HOURS

Weekdays 7am – 4.15pm

## SALES MANAGERS

Position	Name	Phone Number	Fax Number
General Manager (Roofing & Rainwater Goods)	Stewart Porter	(02) 9584 4703 Email: stewart.porter@acegutters.com.au	(02) 9584 4783
General Manager (Plumbing)	Arnold Pulbrook	(02) 9584 4704 Email: arnold.pulbrook@acegutters.com.au	(02) 9584 4785

## SHOWROOM / TECHNICAL ADVICE

	Name	Phone Number	Fax Number
Technical Advisor	Paul West	(02) 9584 4766	(02) 9584 4796

## SALES CONTACTS (Trade)

Position	Name	Phone Number	Fax Number
Area Manager- Sales Sydney & NSW South Coast	Adam Hodgson	0419 533 111	
Technical Sales Representative Plumbing Sydney	Craig Smith	0417 436 805	(02) 9522 0899
Technical Sales Representative Plumbing	Matthew Goodall	50408 597 797	
Technical Sales Representative - North/North West	Cameron Fink	0419 270 875	
Technical Sales Representative -	Ben Reading	0408 597 797	
Area Manager – Sales Newcastle	Bryan Winchester	0408 473 876	(02) 4965 5028
Technical Sales Representative- Newcastle	Ron Kennedy	0408 473 872	
Area Manager – Sales ACT	Joe Marando	0439 245 201	(02) 6238 1380
Technical Sales Representative - ACT	Simon Shea	0478 675 088	(02) 6166 2577

## ORDER/DELIVERY ENQUIRIES

Position	Name	Phone Number	Fax Number
Warehouse & Distribution Manager	Geoff Harmey	(02) 9584 4750	(02) 9584 4799
Operations Manager Warehouse	Shaun Caldwell	(02) 9584 4749	(02) 9584 4799
Sales Office Manager	Daniel Borg	(02) 9584 4752	(02) 9584 4799

## ACCOUNT PAYMENTS

PO Box 99 Mortdale NSW 2223  
– less 2% settlement discount strictly 35 days claimable at time of payment in full  
Bank details for EFT Payments - WESTPAC BSB 032261 Account Number 100313

## FAX ORDERING

To ensure a faster and more efficient service to you the customer you can fax your order direct into our Sheetmetal Customer Service area on Sydney (02) 9584 4799 or on Newcastle (02) 4948 9543 diverted to Sydney toll free or email: sales@acegutters.com.au

**GUTTERING**

NU-LINE GUTTER AND ACCESSORIES	5
MINI-LINE GUTTER & ACCESSORIES	7
SQUARE-LINE GUTTER & ACCESSORIES	9
HALF ROUND GUTTER & ACCESSORIES	11
ROUNDLINE GUTTER & ACCESSORIES	13
QUAD GUTTER & ACCESSORIES	15
STEEL FASCIA & ACCESSORIES	18
BARGE SOAKER	19
FASCIA COVER	19
VALLEY	19

**DOWNPIPES**

90MM ROUND DOWNPIPE & COMPONENTS	20
100 X 50MM ROLLFORM DOWNPIPE & COMPONENTS	22
100 X 75MM ROLLFORM DOWNPIPE & COMPONENTS	23
NOZZLES	25
RAINWATER HEADS	25
LEAF DIVERTER	25
ACCESSORIES	26
NEW LEAFGUARD	26
GUTTER SPACER CLIPS	26

**PREMIUM PRODUCTS**

COASTAL ACE QUAD GUTTER & ACCESSORIES	30
COASTAL HALF ROUND GUTTER & ACCESSORIES	30
COASTAL ROUNDLINE GUTTER & ACCESSORIES	31
COASTAL STEEL FASCIA & ACCESSORIES	31
ACCESSORIES	32
SPECIAL CUTS	33
AVAILABILITY	34
DIMENSIONS	35
COMPATIBILITY	36
DELIVERY SCHEDULES - METROPOLITAN / REGIONAL	37-43
ACE COLOURS	44

# IMPORTANT INFORMATION FOR ACE GUTTERS CUSTOMERS

DEAR CUSTOMER,

The prices listed are effective 2nd April 2018. Please note that the prices and product availability listed are subject to change without notice. This list also cancels all previous price lists.

**ALL PRICES + FEES LISTED ARE EXCLUDING GST.**

## TRADING CARDS

Trading Cards & Badges have been issued for your protection. To place an order your trading card or badge must be shown. For telephone and faxed orders your trading card or badge number must be quoted.

## RETURNS FOR CREDIT

Stock items only may be returned for credit by the customer. They must be returned to our store located at 69 Boundary Road, Mortdale, NSW 2223 **within 14 days of delivery** and have a minimum product value of \$100. Returned product must be in a resalable condition and accompanied with their original invoice copy. A 30% re stocking fee will be charged for goods accepted back into store.

Effective 1st November 2005, a pickup fee of \$110 + GST will apply on all goods collected by Ace Gutters. The minimum product value of goods that will be collected is \$100 exc GST.

## FEES & CHARGES

- (i) All Delivered Rainwater or Plumbing orders incur a delivery fee per order of \$15.00. Returned Goods collected by Ace Gutters incur a \$110 pickup fee and orders must have a minimum product value of \$100 exc GST.  
All delivered Roofing and flashing orders will be \$85 plus GST (roofing orders over 100m). If combined with a gutter order from our profiles rolled on site the fee will remain \$85 plus GST. (i.e gutter delivery inclusive). Delivery fee for Roofing under 100m is \$145 plus GST. Flashing Only Deliveries are \$45 plus GST. Set delivery time for roofing is \$185 plus GST
- (ii) Orders under the product value of \$150.00 exc GST incur an additional \$25.00 +GST minimum delivery fee.
- (iii) Any approved delivery outside delivery borders incurs a \$110.00 +GST delivery fee.
- (iv) If special packaging is required a fee of \$1.10 per metre is charged – minimum charge \$11.00 maximum charge \$100.00 +GST.
- (v) Minimum payment by credit card is \$10.00. 2% settlement fee does not apply to credit card payments.

## CUSTOM CUTS

Custom Cut orders must be received by 10am for next day (weekday) delivery. Custom cuts under 20 metres incur a \$25.00 special cut fee. Roofing Custom Cut fee under 20m incurs a \$50 delivery fee. Please note - the minimum order metreage is calculated on an individual colour and product profile basis. For example if you place an order for a 6.5 metre length of gutter in Dusk and a 6.5m length of fascia in Off White, two fees apply. In this situation please look to order stock lengths. PLEASE ALSO NOTE custom cuts are non returnable and or refundable.

# IMPORTANT INFORMATION FOR ACE GUTTERS CUSTOMERS

## ACE REVISED COLOUR NAMES

ACE EXCLUSIVE COLOURS
Hunter Red
White
Federation Green
Brown
Rivergum
ACE CLASSIC COLOURS
Heritage Red
Smooth Cream
Merino
Jasmin Brown
Slate Grey
Iron Grey
ACE STYLISH COLOURS
Territory
Coventry
Dusk
Off White
Birch
Gull Grey
Armour Grey
Gulf
Manteal
Mist Green
Caulfield Green
Mountain Blue
Basal
Wallaroo
Monolith
Ebony

**NU-LINE GUTTER AND ACCESSORIES**

PRICES EXC GST

Nu-Line

	<p><b>NU-LINE PAINTED GUTTER</b></p> <p><b>DURAKOTE</b></p> <p>80% Gloss Colours White - Brown - Heritage Red - Smooth Cream - Iron Grey - Slate Grey</p>	<p>per metre</p>																								
	<p><u>Stocked Lengths</u> 4 - 6 - 8 - 10 - 12 metres</p> <p>*Custom cuts available - order by 10am for next day delivery (weekdays)</p> <p>*Available Slotted Only*</p>	<p>\$31.61</p>																								
<p><b>NU-LINE PLAIN GUTTER</b></p>	<p><u>Stocked Lengths</u> 4 - 6 - 8 - 10 - 12 metres</p> <p>N.B Plain refers to Zinc Aluminium Coated Steel</p> <p>*Also Available Custom Cut every weekday*</p>	<p>\$26.84</p>																								
	<p><b>NU-LINE BRACKETS</b></p> <table border="0"> <tr> <td>External Bracket Commercial</td> <td>SINGLE</td> <td>GALVANISED</td> <td></td> </tr> <tr> <td>Concealed Bracket - One Piece</td> <td>Pkt 10</td> <td>PLAIN</td> <td></td> </tr> <tr> <td>Bead &amp; Rafter Bracket - complete Two Piece</td> <td>Pkt 10</td> <td>PLAIN</td> <td></td> </tr> <tr> <td>Metal Roof Bracket</td> <td>SINGLE</td> <td>GALVANISED</td> <td></td> </tr> <tr> <td>Project Rafter Bracket</td> <td>SINGLE</td> <td>GALVANISED</td> <td></td> </tr> </table>	External Bracket Commercial	SINGLE	GALVANISED		Concealed Bracket - One Piece	Pkt 10	PLAIN		Bead & Rafter Bracket - complete Two Piece	Pkt 10	PLAIN		Metal Roof Bracket	SINGLE	GALVANISED		Project Rafter Bracket	SINGLE	GALVANISED		<p>per each</p> <p>\$9.60</p> <p>\$34.46</p> <p>\$47.25</p> <p>\$3.23</p> <p>\$3.12</p>				
External Bracket Commercial	SINGLE	GALVANISED																								
Concealed Bracket - One Piece	Pkt 10	PLAIN																								
Bead & Rafter Bracket - complete Two Piece	Pkt 10	PLAIN																								
Metal Roof Bracket	SINGLE	GALVANISED																								
Project Rafter Bracket	SINGLE	GALVANISED																								
	<p><b>NU-LINE FEATURE DIECAST FITTINGS</b></p> <table border="0"> <tr> <td>External 90° Angle</td> <td>2 PIECE</td> <td>PAINTED</td> <td></td> </tr> <tr> <td>Internal 90° Angle</td> <td>2 PIECE</td> <td>PAINTED</td> <td></td> </tr> <tr> <td>Project Straight Joiner</td> <td></td> <td>PAINTED</td> <td></td> </tr> </table> <p>*Colours as per Gutter*</p> <table border="0"> <tr> <td>External 90° Angle</td> <td>2 PIECE</td> <td>PLAIN</td> <td></td> </tr> <tr> <td>Internal 90° Angle</td> <td>2 PIECE</td> <td>PLAIN</td> <td></td> </tr> <tr> <td>Project Straight Joiner</td> <td></td> <td>PLAIN</td> <td></td> </tr> </table> <p>N.B Joiner without inserts - pop rivets and speed nuts provided</p>	External 90° Angle	2 PIECE	PAINTED		Internal 90° Angle	2 PIECE	PAINTED		Project Straight Joiner		PAINTED		External 90° Angle	2 PIECE	PLAIN		Internal 90° Angle	2 PIECE	PLAIN		Project Straight Joiner		PLAIN		<p>per each</p> <p>\$61.77</p> <p>\$61.77</p> <p>\$23.61</p> <p>\$59.04</p> <p>\$59.04</p> <p>\$20.43</p>
External 90° Angle	2 PIECE	PAINTED																								
Internal 90° Angle	2 PIECE	PAINTED																								
Project Straight Joiner		PAINTED																								
External 90° Angle	2 PIECE	PLAIN																								
Internal 90° Angle	2 PIECE	PLAIN																								
Project Straight Joiner		PLAIN																								
	<p><b>NU-LINE PAINTED STOP ENDS</b></p> <p>*Colours as per Gutter*</p> <p><b>DURAKOTE</b></p> <p><b>NU-LINE PLAIN STOP ENDS</b></p> <p>N.B Plain refers to Zinc Aluminium Coated Steel</p>	<p>per pair</p> <p>\$16.54</p> <p>\$15.11</p>																								
	<p><b>NU-LINE TEMPLATES</b></p>	<p>per each</p> <p>\$6.71</p>																								
	<p><b>NU-LINE LEAFGUARD PAINTED</b></p> <p><b>DURAKOTE</b></p> <p><u>Colours</u> Slate Grey Ebony - Mountain Blue</p>	<p>per length</p>																								
<p>155 mm</p>	<p><u>Length</u> 155mm x 2500mm</p> <p><b>NU-LINE LEAFGUARD PLAIN</b></p> <p><u>Length</u> 155mm x 2500mm</p> <p>N.B Plain refers to Zinc Aluminium Coated Steel</p> <p>*When External Nu-Line Brackets are used Concealed Brackets are required to support the leafguard*</p>	<p>\$45.29</p> <p>\$36.27</p>																								



For Downpipe & Components Refer to Page 20

For Accessories & Tools (Pop Rivets, Nails, Sealer etc) Refer to Page 26



## CUSTOM CUTTING SERVICE for **NU-LINE**

Ace Gutters custom cut Nu-Line (Plain & Painted) every weekday in the following lengths:

SYDNEY 2 metres to 12 metres in 0.1m rises

NEWCASTLE 2 metres to 12 metres in 0.1m rises

WOLLONGONG 2 metres to 12 metres in 0.1m rises

CANBERRA 2 metres to 12 metres in 0.1m rises

Please Note:

(i) Orders must be received by 10am if next day delivery is required.

(ii) All custom cuts under 20 metres incur a \$25.00 cutting fee – the minimum order metreage is calculated on an individual colour and profile basis – eg an order for 1 x 10.5m length of Nu-Line White and 1 x 10.5m length of Nu-Line Brown incurs two minimum cut fees.

(iii) Custom Cuts are non returnable.

N.B Plain refers to Zinc Aluminium Coated Steel

## ACE GUTTERS CUSTOM CUT THE FOLLOWING PRODUCTS

- Nu-Line Gutter
- Mini-Line Gutter
- Square-Line Gutter
- Half Round Gutter
- Roundline
- Ace Quad & Old Style Quad
- 90mm Round Downpipe
- 100 x 50mm & 100 x 75mm  
Rollform Downpipe

Please note: Custom Cuts are non returnable

Orders to be received by 10am for next day delivery.

All custom cuts under 20 metres incur a \$25.00 exc GST charge.





For Downpipe & Components Refer to Page 20

For Accessories & Tools (Pop Rivets, Nails, Sealer etc) Refer to Page 26



## CUSTOM CUTTING SERVICE for **MINI-LINE**

Ace Gutters can custom cut Mini-Line (Plain & Painted) every weekday in the following lengths:

SYDNEY 2 metres to 12 metres in 0.1m rises

NEWCASTLE 2 metres to 12 metres in 0.1m rises

WOLLONGONG 2 metres to 12 metres in 0.1m rises

CANBERRA 2 metres to 12 metres in 0.1m rises

Please Note:

(i) Orders must be received by 10am if next day delivery is required.

(ii) All custom cuts under 20 metres incur a \$25.00 cutting fee – the minimum order metreage is calculated on an individual colour and profile basis – eg an order for 1 x 10.5m length of Mini-Line Smooth Cream and 1 x 10.5m length of Mini-Line Brown incurs two minimum cut fees.

(iii) Custom Cuts are non returnable.

N.B Plain refers to Zinc Aluminium Coated Steel

# SQUARE-LINE GUTTER & ACCESSORIES

PRICES EXC GST

	<p><b>SQUARE-LINE PAINTED GUTTER</b>  <u>80% Gloss Colours</u>                  White - Brown - Heritage Red - Smooth Cream - Merino                  Jasmin Brown - Iron Grey- Slate Grey</p> <p><u>25% Gloss Colours</u>                  Rivergum - Dusk - Off White - Birch - Gull Grey - Armour Grey                  Mist Green - Caulfield Green - Mountain Blue - Monolith - Ebony                  Wallaroo - Manteal - Basal - Gulf - Coventry - Territory</p> <p><u>Custom Cut Only</u>                  2 metres to 12 metres in 0.1 metre rises                  *Orders to be received by 10am*                  All colours available custom cut every weekday</p> <p><b>SQUARE-LINE PLAIN GUTTER</b>  <u>Custom Cut Only</u>                  2 metres to 12 metres in 0.1 metre rises                  N.B Plain refers to Zinc Aluminium Coated Steel                  *Orders to be received by 10am* Custom cut every weekday                  *Square-line available slotted only</p>		<p>per metre</p> <p>\$18.43</p> <p>\$15.98</p>												
	<p><b>SQUARE-LINE BRACKETS</b></p> <table border="0"> <tr> <td>Overstrap Bracket</td> <td>PKT 10</td> <td>PLAIN</td> </tr> <tr> <td>Concealed Suspension Bracket</td> <td>PKT 10</td> <td>PLAIN</td> </tr> <tr> <td>Metal Fascia Suspension Clips</td> <td>PKT 10</td> <td></td> </tr> <tr> <td>Timber Fascia Suspension Clips</td> <td>PKT 10</td> <td></td> </tr> </table>	Overstrap Bracket	PKT 10	PLAIN	Concealed Suspension Bracket	PKT 10	PLAIN	Metal Fascia Suspension Clips	PKT 10		Timber Fascia Suspension Clips	PKT 10			<p>per each</p> <p>\$21.70</p> <p>\$41.69</p> <p>\$23.63</p> <p>\$23.63</p>
Overstrap Bracket	PKT 10	PLAIN													
Concealed Suspension Bracket	PKT 10	PLAIN													
Metal Fascia Suspension Clips	PKT 10														
Timber Fascia Suspension Clips	PKT 10														
	<p><b>SQUARE-LINE PAINTED STOP ENDS</b>                  *Colours as per Gutter*</p> <p><b>SQUARE-LINE PLAIN STOP ENDS</b></p>		<p>per pair</p> <p>\$7.08</p> <p>\$6.80</p>												
	<p><b>SQUARE-LINE LEAFGUARD PAINTED</b>  <u>Colours</u>                  Slate Grey - Ebony - Mountain Blue</p> <p><u>Length</u>                  120mm x 2500mm</p> <p><b>SQUARE-LINE LEAFGUARD PLAIN</b></p> <p><u>Length</u>                  120mm x 2500mm                  N.B Plain refers to Zinc Aluminium Coated Steel                  *Please use Ace Square-line overstrap brackets when installing leafguards.*</p>		<p>per length</p> <p>\$33.75</p> <p>\$27.52</p>												
	<p>For Downpipe &amp; Components Refer to Page 20                  For Accessories &amp; Tools (Pop Rivets, Nails, Sealer etc) Refer to Page 26</p>														

Square-Line

## CUTTING ANGLES FOR SQUARE-LINE

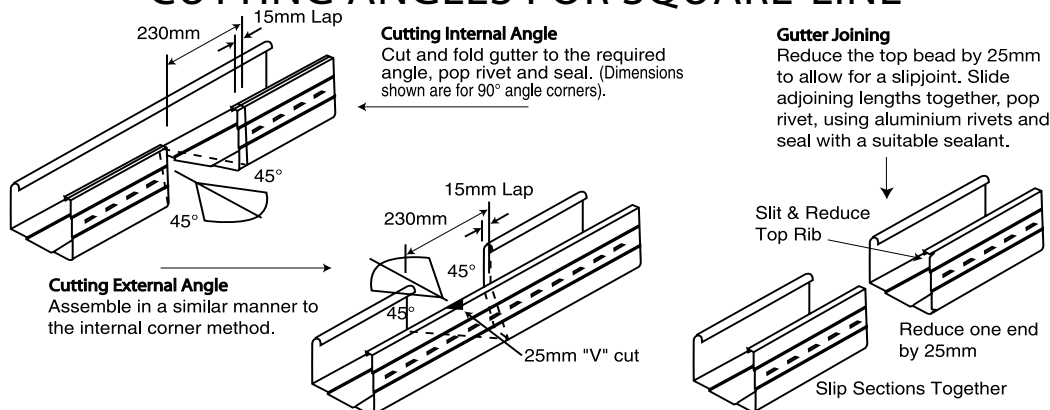

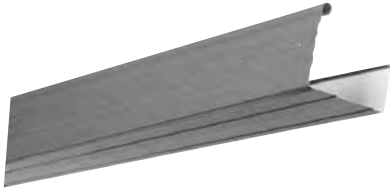

# CUSTOM CUTTING SERVICE for SQUARE-LINE

Ace Gutters can custom cut every weekday - any colour Square-Line (Plain & Painted) in the following lengths:

SYDNEY	2 metres to 12 metres in 0.1m rises
NEWCASTLE	2 metres to 12 metres in 0.1m rises
WOLLONGONG	2 metres to 12 metres in 0.1m rises
CANBERRA	2 metres to 12 metres in 0.1m rises

Please Note:

- (i) Orders must also be received by 10am on the custom cutting day if next day delivery is required.
- (ii) All custom cuts under 20 metres incur a \$25.00 cutting fee – the minimum order metreage is calculated on an individual colour and profile basis – eg an order for 1 x 10m length of Square-Line Smooth Cream and 1 x 10m length of Square-Line Brown incurs two minimum cut fees.
- (iii) We do not hold in stock any Square-Line – this product is only custom cut.
- (iv) Custom Cuts are non returnable.

N.B Plain refers to Zinc Aluminium Coated Steel

Square-Line

**NOW AVAILABLE  
NEW PRODUCT**



**ACE QUAD  
OVERFLOW  
NOZZLE**

Also available in  
Half Round & Roundline



Available in all colours:

- 100mm x 50mm = an additional overflow capacity of 142%
- 100mm x 75mm = an additional overflow capacity of 112%
- 90mm = an additional overflow capacity of 104%

Template and fixing instructions supplied with every order

# HALF ROUND GUTTER & ACCESSORIES

PRICES EXC GST

	<p><b>HALF ROUND PAINTED GUTTER - 150mm</b>                  80% &amp; 25% Gloss Ace Classic Colours                  Heritage Red - Smooth Cream - Merino - Jasmin Brown</p>		<p>per metre</p>																								
	<p>Slate Grey - Iron Grey</p> <p><u>25% Gloss Ace Stylish Colours</u></p> <p>Territory - Coventry - Dusk - Off White - Birch - Gull Grey - Armour Grey                  Gulf - Manteal - Mist Green - Caulfield Green - Mountain Blue</p>																										
	<p>Basal - Wallaroo - Monolith - Ebony</p> <p>Available in <u>SLOTTED</u> or <u>UNSLOTTED</u>  <u>Custom Cut Only</u></p> <p>2 metres to 10 metres in 0.1 metre rises                  *All colours are available custom cut every weekday*                  *Orders to be received by 10am*</p>		<p>\$21.29</p>																								
	<p><b>HALF ROUND PLAIN GUTTER - 150mm</b>                  Available in <u>SLOTTED</u> or <u>UNSLOTTED</u>  <u>Custom Cut Only</u></p> <p>2 metres to 10 metres in 0.1 metre rises</p> <p>N.B Plain refers to Zinc Aluminium Coated Steel                  *Custom cut every weekday*                  *Orders to be received by 10am*                  Also available in Painted Coastal to Page 30</p>		<p>\$18.15</p>																								
	<p><b>HALF ROUND FEATURE DIECAST FITTINGS</b></p> <table border="0"> <tr> <td>External 90° or External 45° Angle</td> <td>2 PIECE</td> <td>PAINTED</td> <td>\$33.29</td> </tr> <tr> <td>Internal 90° or Internal 45° Angle</td> <td>2 PIECE</td> <td>PAINTED</td> <td>\$33.29</td> </tr> <tr> <td>External Bracket</td> <td>PKT 5</td> <td>PAINTED</td> <td>\$71.16</td> </tr> </table> <p style="text-align: center;">*Colours as per Gutter*</p> <table border="0"> <tr> <td>External 90° or External 45° Angle</td> <td>2 PIECE</td> <td>PLAIN</td> <td>\$30.03</td> </tr> <tr> <td>Internal 90° or Internal 45° Angle</td> <td>2 PIECE</td> <td>PLAIN</td> <td>\$30.03</td> </tr> <tr> <td>External Bracket</td> <td>PKT 5</td> <td>PLAIN</td> <td>\$62.94</td> </tr> </table> <p>*N.B. No Concealed brackets available use External Brackets only*                  *15 screws are provided with every 5 packet of external brackets*                  * Angle Cutting Templates (90° &amp; 45°) are supplied with every order*                  *Orders to be received by 10am as not stocked*</p>	External 90° or External 45° Angle	2 PIECE	PAINTED	\$33.29	Internal 90° or Internal 45° Angle	2 PIECE	PAINTED	\$33.29	External Bracket	PKT 5	PAINTED	\$71.16	External 90° or External 45° Angle	2 PIECE	PLAIN	\$30.03	Internal 90° or Internal 45° Angle	2 PIECE	PLAIN	\$30.03	External Bracket	PKT 5	PLAIN	\$62.94		<p>per each</p>
External 90° or External 45° Angle	2 PIECE	PAINTED	\$33.29																								
Internal 90° or Internal 45° Angle	2 PIECE	PAINTED	\$33.29																								
External Bracket	PKT 5	PAINTED	\$71.16																								
External 90° or External 45° Angle	2 PIECE	PLAIN	\$30.03																								
Internal 90° or Internal 45° Angle	2 PIECE	PLAIN	\$30.03																								
External Bracket	PKT 5	PLAIN	\$62.94																								
	<p><b>HALF ROUND PAINTED STOP ENDS</b>                  *Colours as per Gutter*</p> <p></p> <p><b>HALF ROUND PLAIN STOP ENDS</b>                  N.B Plain refers to Zinc Aluminium Coated Steel                  *Orders to be received by 10am as not stocked*</p>		<p>per pair                  \$16.53                  \$15.11</p>																								
	<p><b>NOZZLES</b></p> <table border="0"> <tr> <td>90mm Half Round Nozzle</td> <td>PAINTED</td> <td>\$15.15</td> </tr> <tr> <td>100 x 50mm Half Round Nozzle</td> <td>PAINTED</td> <td>\$15.15</td> </tr> <tr> <td>100 x 75mm Half Round Nozzle</td> <td>PAINTED</td> <td>\$15.15</td> </tr> </table> <p style="text-align: center;">*Colours as per Gutter*</p> <table border="0"> <tr> <td>90mm Half Round Nozzle</td> <td>PLAIN</td> <td>\$14.06</td> </tr> <tr> <td>100 x 50mm Half Round Nozzle</td> <td>PLAIN</td> <td>\$14.06</td> </tr> <tr> <td>100 x 75mm Half Round Nozzle</td> <td>PLAIN</td> <td>\$14.06</td> </tr> </table> <p>Refer to Page 20 for Downpipe and components                  *Orders to be received by 10am as not stocked*</p>	90mm Half Round Nozzle	PAINTED	\$15.15	100 x 50mm Half Round Nozzle	PAINTED	\$15.15	100 x 75mm Half Round Nozzle	PAINTED	\$15.15	90mm Half Round Nozzle	PLAIN	\$14.06	100 x 50mm Half Round Nozzle	PLAIN	\$14.06	100 x 75mm Half Round Nozzle	PLAIN	\$14.06		<p>per each                  \$15.15                  \$15.15                  \$15.15                  \$14.06                  \$14.06                  \$14.06</p>						
90mm Half Round Nozzle	PAINTED	\$15.15																									
100 x 50mm Half Round Nozzle	PAINTED	\$15.15																									
100 x 75mm Half Round Nozzle	PAINTED	\$15.15																									
90mm Half Round Nozzle	PLAIN	\$14.06																									
100 x 50mm Half Round Nozzle	PLAIN	\$14.06																									
100 x 75mm Half Round Nozzle	PLAIN	\$14.06																									

Half Round

	<b>HALF ROUND OVERFLOW NOZZLES *NEW*</b> 90mm Half Round Overflow Nozzle 100 x 50mm Half Round Overflow Nozzle 100 x 75mm Half Round Overflow Nozzle *Colours as per Gutter*	PAINTED PAINTED PAINTED	per each \$33.84 \$33.84 \$33.84
	90mm Half Round Overflow Nozzle 100 x 50mm Half Round Overflow Round Nozzle 100 x 75mm Half Round Overflow Round Nozzle *Orders to be received by 10am as not stocked*	PLAIN PLAIN PLAIN	\$26.14 \$26.14 \$26.14
	<b>HALF ROUND LEAFGUARD PAINTED</b> <u>Colours</u> Slate Grey - Mountain Blue - Ebony		per length
	<u>Length</u> 155mm x 2500mm		\$59.55
	<b>HALF ROUND LEAFGUARD PLAIN</b> <u>Length</u> 155mm x 2500mm * Brackets supplied for fixing to gutter N.B Plain refers to Zinc Aluminium Coated Steel		\$50.21
	For Accessories & Tools (Pop Rivets, Nails, Sealer etc) Refer to Page 26		

## FIXING INSTRUCTIONS FOR HALF ROUND

HALF ROUND: RECOMMENDED FOR USE ON TIMBER FASCIA BOARD

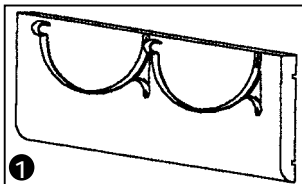

1. Screw external brackets to Fascia leave top hole blank with fall to downpipe using stringline.

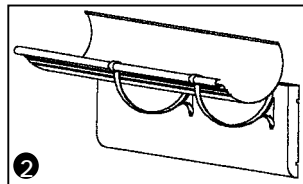

2. Roll gutter into brackets.

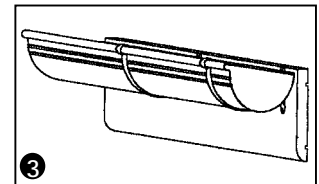

3. Secure back of gutter with screw in available hole on top of bracket.



## CUSTOM CUTTING SERVICE for HALF ROUND

Ace Gutters custom cut Half Round every weekday – (Plain, Painted & Coastal).

The lengths available are as follows:

SYDNEY	2 metres to 10 metres in 0.1m rises
NEWCASTLE	2 metres to 10 metres in 0.1m rises
WOLLONGONG	2 metres to 10 metres in 0.1m rises
CANBERRA	2 metres to 10 metres in 0.1m rises

Please Note:

- (i) Orders must be received by 10am on any weekday if next day delivery is required. (No deliveries – Saturday).
- (ii) All custom cuts under 20 metres incur a \$25.00 cutting fee – the minimum order metreage is calculated on an individual colour and profile basis – eg an order for 1 x 10m length of Half Round in Smooth Cream and 1 x 10m length of Half Round in Slate Grey incurs two minimum cut fees.
- (iii) We do not stock any lengths in Half Round – this product is only custom cut.
- (iv) Custom Cuts are non returnable.

N.B Plain refers to Zinc Aluminium Coated Steel

# ROUNDLINE GUTTER & ACCESSORIES

PRICES EXC GST

	<p><b>ROUNDLINE PAINTED GUTTER - 150mm</b>  <u>80% &amp; 25% Gloss Ace Classic Colours</u>                  Heritage Red - Smooth Cream - Merino - Jasmin Brown                   Slate Grey - Iron Grey</p>		<p>per metre</p>																		
	<p><u>25% Gloss Ace Stylish Colours</u>                  Territory - Coventry - Dusk - Off White - Birch - Gull Grey - Armour Grey                  Gulf - Mantel - Mist Green - Caulfield Green - Mountain Blue                   Basal - Wallaroo - Monolith - Ebony</p>																				
	<p>Available in <u>SLOTTED</u> or <u>UNSLOTTED</u>  <u>Custom Cut Only</u>                  2 metres to 10 metres in 0.1 metre rises                  *All colours are available custom cut every weekday*                  *Orders to be received by 10am*</p>		<p>\$21.29</p>																		
	<p><b>ROUNDLINE PLAIN GUTTER - 150mm</b>                  Available in <u>SLOTTED</u> or <u>UNSLOTTED</u>  <u>Custom Cut Only</u>                  2 metres to 10 metres in 0.1 metre rises                   N.B Plain refers to Zinc Aluminium Coated Steel                  *Custom cut every weekday*                  *Orders to be received by 10am*                  Also available in Painted Coastal Refer to Page 31</p>		<p>\$18.15</p>																		
	<p><b>ROUNDLINE BRACKETS</b></p> <table border="0"> <tr> <td>Concealed Suspension Bracket</td> <td>PKT 10</td> <td>PLAIN</td> </tr> <tr> <td>Overstrap Bracket</td> <td>PKT 10</td> <td>PLAIN</td> </tr> <tr> <td>Metal Fascia Suspension Clip</td> <td>PKT 10</td> <td></td> </tr> <tr> <td>Timber Fascia Suspension Clip</td> <td>PKT 10</td> <td></td> </tr> </table> <p>* N.B No External brackets available*</p>	Concealed Suspension Bracket	PKT 10	PLAIN	Overstrap Bracket	PKT 10	PLAIN	Metal Fascia Suspension Clip	PKT 10		Timber Fascia Suspension Clip	PKT 10			<p>per each                  \$41.71                  \$26.15                  \$23.63                  \$23.63</p>						
Concealed Suspension Bracket	PKT 10	PLAIN																			
Overstrap Bracket	PKT 10	PLAIN																			
Metal Fascia Suspension Clip	PKT 10																				
Timber Fascia Suspension Clip	PKT 10																				
	<p><b>ROUNDLINE FEATURE DIECAST FITTINGS</b></p> <table border="0"> <tr> <td>External 90° or External 45° Angle</td> <td>2 PIECE</td> <td>PAINTED</td> </tr> <tr> <td>Internal 90° or Internal 45° Angle</td> <td>2 PIECE</td> <td>PAINTED</td> </tr> </table> <p>*Colours as per Gutter*</p> <table border="0"> <tr> <td>External 90° or External 45° Angle</td> <td>2 PIECE</td> <td>PLAIN</td> </tr> <tr> <td>Internal 90° or Internal 45° Angle</td> <td>2 PIECE</td> <td>PLAIN</td> </tr> </table> <p>* Angle Cutting Templates (90° &amp; 45°) are supplied with every order                  *Orders to be received by 10am as not stocked*</p>	External 90° or External 45° Angle	2 PIECE	PAINTED	Internal 90° or Internal 45° Angle	2 PIECE	PAINTED	External 90° or External 45° Angle	2 PIECE	PLAIN	Internal 90° or Internal 45° Angle	2 PIECE	PLAIN		<p>per each                  \$33.29                  \$33.29                   \$30.03                  \$30.03</p>						
External 90° or External 45° Angle	2 PIECE	PAINTED																			
Internal 90° or Internal 45° Angle	2 PIECE	PAINTED																			
External 90° or External 45° Angle	2 PIECE	PLAIN																			
Internal 90° or Internal 45° Angle	2 PIECE	PLAIN																			
	<p><b>ROUNDLINE PAINTED STOP ENDS</b>                  *Colours as per Gutter*</p> <p><b>ROUNDLINE PLAIN STOP ENDS</b>                  N.B Plain refers to Zinc Aluminium Coated Steel                  *Orders to be received by 10am as not stocked*</p>		<p>per pair                  \$16.53                   \$15.11</p>																		
	<p><b>NOZZLES</b></p> <table border="0"> <tr> <td>90mm Half Round Nozzle</td> <td></td> <td>PAINTED</td> </tr> <tr> <td>100 x 50mm Half Round Nozzle</td> <td></td> <td>PAINTED</td> </tr> <tr> <td>100 x 75mm Half Round Nozzle</td> <td></td> <td>PAINTED</td> </tr> </table> <p>*Colours as per Gutter*</p> <table border="0"> <tr> <td>90mm Half Round Nozzle</td> <td></td> <td>PLAIN</td> </tr> <tr> <td>100 x 50mm Half Round Nozzle</td> <td></td> <td>PLAIN</td> </tr> <tr> <td>100 x 75mm Half Round Nozzle</td> <td></td> <td>PLAIN</td> </tr> </table> <p>Refer to Page 20 for Downpipe and components                  *Orders to be received by 10am as not stocked*</p>	90mm Half Round Nozzle		PAINTED	100 x 50mm Half Round Nozzle		PAINTED	100 x 75mm Half Round Nozzle		PAINTED	90mm Half Round Nozzle		PLAIN	100 x 50mm Half Round Nozzle		PLAIN	100 x 75mm Half Round Nozzle		PLAIN		<p>per each                  \$15.15                  \$15.15                  \$15.15                   \$14.06                  \$14.06                  \$14.06</p>
90mm Half Round Nozzle		PAINTED																			
100 x 50mm Half Round Nozzle		PAINTED																			
100 x 75mm Half Round Nozzle		PAINTED																			
90mm Half Round Nozzle		PLAIN																			
100 x 50mm Half Round Nozzle		PLAIN																			
100 x 75mm Half Round Nozzle		PLAIN																			

	<b>ROUNDLINE OVERFLOW NOZZLES *NEW*</b> 90mm Roundline Overflow Nozzle 100 x 50mm Roundline Overflow Nozzle 100 x 75mm Roundline Overflow Nozzle *Colours as per Gutter*	PAINTED PAINTED PAINTED	per each \$33.84 \$33.84 \$33.84
	90mm Roundline Overflow Nozzle 100 x 50mm Roundline Overflow Round Nozzle 100 x 75mm Roundline Overflow Round Nozzle *Orders to be received by 10am as not stocked*	PLAIN PLAIN PLAIN	\$26.14 \$26.14 \$26.14
	<b>ROUNDLINE LEAFGUARD PAINTED</b> <u>Colours</u> Slate Grey - Mountain Blue - Ebony		per length
	<u>Length</u> 155mm x 2500mm		\$45.30
	<b>ROUNDLINE LEAFGUARD PLAIN</b> <u>Length</u> 155mm x 2500mm Please Note: Use overstrap brackets for fixing N.B Plain refers to Zinc Aluminium Coated Steel		\$36.29
	For Accessories & Tools (Pop Rivets, Nails, Sealer etc) Refer to Page 26		

## FIXING INSTRUCTIONS FOR ROUNDLINE

### ROUNDLINE: TO ACE STEEL FASCIA

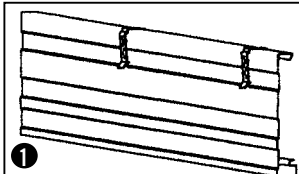

1. Place suspension clips along top of fascia at approx. 1.2 metre centres.
2. Snap gutter into place and adjust fall to downpipe.
3. Insert internal overstrap gutter brackets.

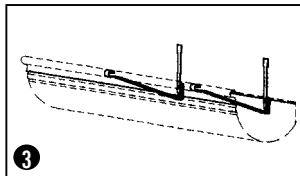
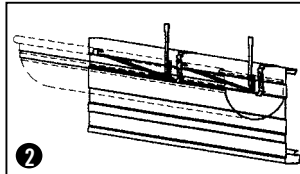

### ROUNDLINE: TO TIMBER FASCIA WITH TIMBER SUSPENSION CLIP

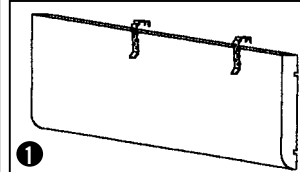

1. Nail timber suspension clips to timber fascia.
2. Snap gutter into place and adjust fall to downpipe.
3. Insert internal overstrap gutter brackets.

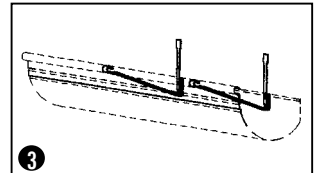
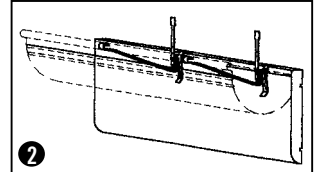

## CUSTOM CUTTING SERVICE for ROUNDLINE

Ace Gutters custom cut Roundline every weekday – (Plain, Painted & Coastal).

The lengths available are as follows:

SYDNEY	2 metres to 10 metres in 0.1m rises
NEWCASTLE	2 metres to 10 metres in 0.1m rises
WOLLONGONG	2 metres to 10 metres in 0.1m rises
CANBERRA	2 metres to 10 metres in 0.1m rises

Please Note:

- Orders must be received by 10am on any weekday if next day delivery is required. (No deliveries – Saturday)
- All custom cuts under 20 metres incur a \$25.00 cutting fee – the minimum order metreage is calculated on an individual colour and profile basis – eg an order for 1 x 10m length of Roundline in Smooth Cream and 1 x 10m length of Roundline in Slate Grey incurs two minimum cut fees.
- We do not stock any lengths in Roundline – this product is only custom cut.
- Custom Cuts are non returnable.

N.B Plain refers to Zinc Aluminium Coated Steel

**QUAD GUTTER & ACCESSORIES**

PRICES EXC GST

Quad Gutter

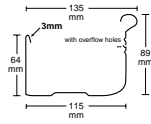

**ACE QUAD PAINTED GUTTER - 115mm**

80% Gloss Ace Exclusive Colours

Hunter Red - White - Federation Green - Brown

80% & 25% Gloss Ace Classic Colours

Heritage Red - Smooth Cream - Merino - Jasmin Brown

Slate Grey - Iron Grey

25% Gloss Ace Stylish Colours

Territory - Coventry - Dusk - Off White - Birch - Gull Grey - Armour Grey - Gulf

Manteal - Mist Green - Caulfield Green - Mountain Blue - Basal - Wallaroo - Monolith - Ebony

Stocked Lengths

3 - 5 - 6 - 8 - 10 - 12 metres

\*Also Available Custom Cut every weekday\*

\*Orders to be received by 10am on Cutting Day\*

Unslotted Painted Ace Quad is Available - Custom Cut Only

\*Rivergum is available as a Custom Cut Only in 25% Gloss\*

**ACE QUAD PLAIN GUTTER - 115mm**

Stocked Lengths

3 - 5 - 6 - 8 - 10 - 12 metres

\*Also Available Custom Cut every weekday\*

\*Orders to be received by 10am on Cutting Day\*

Also available in Painted Coastal Refer to Page 30

N.B Plain refers to Zinc Aluminium Coated Steel



per metre

\$17.65

\$15.23

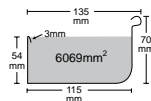
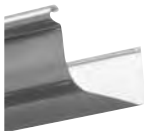

**OLD STYLE QUAD PAINTED GUTTER - 115mm**

80% Gloss Colours

Hunter Red - White - Federation Green

Brown - Heritage Red - Smooth Cream - Merino

Jasmin Brown - Slate Grey - Iron Grey

25% Gloss Colours

Territory - Coventry - Dusk - Off White - Birch - Gull Grey - Armour Grey

Gulf - Manteal - Mist Green - Caulfield Green - Mountain Blue

Basal - Wallaroo - Monolith - Ebony

Custom Cut Only

2 metres to 12 metres in 0.1 metre rises

\*Orders to be received by 10am\* - Including accessories

\*All colours are available custom cut every weekday\*

**OLD STYLE QUAD PLAIN GUTTER - 115mm**

2 metres to 12 metres in 0.1 metre rises

N.B Plain refers to Zinc Aluminium Coated Steel

\*Orders to be received by 10am\* - Including accessories

\*Custom cut every weekday\*

\*Old Style available unslotted only\*



per metre

\$17.65

\$15.23

				PRICES EXC GST
	<b>QUAD BRACKETS</b> External Bracket	PKT 5	PAINTED	per each \$16.14
	*Colours as per Gutter*			
	External Bracket	SINGLE	PLAIN	\$2.20
	Concealed Bracket	PKT 10	PLAIN	\$15.62
	Overstrap Bracket	PKT 10	PLAIN	\$22.98
	Concealed Suspension Bracket*	PKT 10	PLAIN	\$41.69
	Metal Fascia Suspension Clips	PKT 10	*Ace Quad Only*	\$23.63
Timber Fascia Suspension Clips	PKT 10		\$23.63	
*Quad Brackets are suitable for both ace quad and old style quad except for Concealed Suspension Bracket which is to be used only on Ace Quad*				
	<b>QUAD FEATURE DIECAST FITTINGS</b> External 90° or External 45° Angle*	2 PIECE	PAINTED	per each \$22.03
	Internal 90° or Internal 45° Angle*	2 PIECE	PAINTED	\$22.03
	*Colours as per Gutter*			
	External 90° or External 45° Angle*	2 PIECE	PLAIN	\$19.44
Internal 90° or Internal 45° Angle*	2 PIECE	PLAIN	\$19.44	
*45° Angle Available for Ace Quad only*				
	<b>QUAD PAINTED STOP ENDS</b> *Colours as per Gutter*			per pair \$6.56
	<b>QUAD PLAIN STOP ENDS</b> N.B Plain refers to Zinc Aluminium Coated Steel			\$6.04
	ACE QUAD* Return Stop End Left Hand or Right Hand *Colours as per Gutter*		PAINTED	\$26.34
	ACE QUAD* Return Stop End Left Hand or Right Hand N.B Plain refers to Zinc Aluminium Coated Steel *Available for Ace Quad only		PLAIN	\$24.53
	<b>QUAD LEAFGUARD PAINTED</b>			per length
	<u>Colours</u> Slate Grey - Mountain Blue - Ebony			
	<u>Length</u> 120mm x 2500mm			\$33.75
	<b>QUAD LEAFGUARD PLAIN</b> <u>Length</u> 120mm x 2500mm N.B Plain refers to Zinc Aluminium Coated Steel *When External Brackets are used Concealed Brackets are required to support the leafguard.* *Leafguard to be notched for fitting to suspension bracket.*			\$27.52
	<b>QUAD OVERFLOW NOZZLES *NEW*</b>			per each
	90mm Quad Overflow Nozzle		PAINTED	\$33.84
	100 x 50mm Quad Overflow Nozzle		PAINTED	\$33.84
	100 x 75mm Quad Overflow Nozzle		PAINTED	\$33.84
	*Colours as per Gutter* * Custom Spray - Orders to be received by 10am*			
	90mm Quad Overflow Nozzle		PLAIN	\$26.14
100 x 50mm Quad Overflow Round Nozzle		PLAIN	\$26.14	
100 x 75mm Quad Overflow Round Nozzle		PLAIN	\$26.14	
*Orders to be received by 10am as not stocked*				
	For Accessories & Tools (Pop Rivets, Nails, Sealer etc) Refer to Page 26			



## CUSTOM CUTTING SERVICE for ACE QUAD

Ace Gutters custom cuts Ace Quad every weekday, any colour (Plain & Painted) in the following lengths:

SYDNEY	2 metres to 12 metres in 0.1m rises
NEWCASTLE	2 metres to 12 metres in 0.1m rises
WOLLONGONG	2 metres to 12 metres in 0.1m rises
CANBERRA	2 metres to 12 metres in 0.1m rises

Please Note:

- (i) Orders must be received by 10am if next day delivery is required.
- (ii) All custom cuts under 20 metres incur a \$25.00 cutting fee – the minimum order metreage is calculated on an individual colour and profile basis – eg an order for 1 x 10m length of Ace Quad/Old Style Quad Hunter Red and 1 x 10m length of Ace Quad/Old Style Quad Brown incurs two minimum cut fees.
- (iii) Custom Cuts are non returnable.

N.B Plain refers to Zinc Aluminium Coated Steel



## CUSTOM CUTTING SERVICE for OLD STYLE QUAD

Ace Gutters custom cut Old Style Quad every weekday, any colour (Plain & Painted) in the following lengths:

SYDNEY	2 metres to 12 metres in 0.1m rises
NEWCASTLE	2 metres to 12 metres in 0.1m rises
WOLLONGONG	2 metres to 12 metres in 0.1m rises
CANBERRA	2 metres to 12 metres in 0.1m rises

Conditions apply, see Ace Quad Notes above.

### CONCEALED GUTTER

PRICES EXC GST



CONCEALED GUTTER WASHCOAT (NETT)

Stocked Length

4 & 8 metres

Refer to page 35 for dimensions

per length

\$41.06

### CAPPING

PRICES EXC GST



CAPPING PLAIN

Stocked Length

2.4 metres

Refer to page 35 for dimensions

per length

\$27.30

### SOAKER FLASHING

PRICES EXC GST



SOAKER FLASHING

Stocked Length

2.4 metres

Refer to page 35 for dimensions

per length

\$11.12



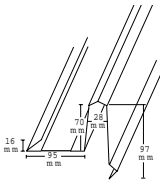

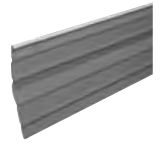
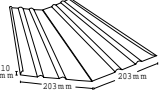

BARGE SOAKER		PRICES EXC GST
  	<p><b>BARGE SOAKER PAINTED</b></p> <p><b>80% Gloss Colours</b>                      Hunter Red - White - Federation Green - Brown                      Heritage Red - Smooth Cream - Merino - Slate Grey                      Jasmin Brown - Iron Grey</p> <p><b>25% Gloss Colours</b>                      Rivergum - Territory - Coventry - Dusk - Off White - Birch - Gull Grey                      Armour Grey- Gulf -Manteal - Mist Green - Caulfield Green -Mountain Blue                      - Basal - Wallaroo - Monolith - Ebony</p> <p><u>Stocked Lengths</u>                      3 - 5 - 7 metres</p> <p><u>No Custom Cuts Available</u></p>	<p>per metre</p> <p><b>DURAKOTE</b></p> <p>\$22.73</p>
	<p><b>BARGE SOAKER PLAIN</b></p> <p>N.B Plain refers to Zinc Aluminium Coated Steel</p> <p><u>Stocked Lengths</u>                      3 - 5 - 7 metres</p> <p><u>No Custom Cuts Available</u></p> <p>Also available in Painted Coastal Refer to Page 32</p>	<p>\$20.62</p>

FASCIA COVER		PRICES EXC GST
  	<p><b>FASCIA COVER PAINTED 25% Gloss</b></p> <p><b>25% Gloss Colours</b>                      White - Brown - Rivergum                      Heritage Red - Smooth Cream - Merino - Jasmin Brown                      Slate Grey - Iron Grey - Territory - Coventry - Dusk - Off White - Birch - Gull Grey                      Armour Grey - Gulf - Manteal- Mist Green- Caulfield Green - Mountain Blue                      Basal - Wallaroo - Monolith - Ebony</p> <p><u>Stocked Lengths</u>                      6 metres</p> <p><u>No Custom Cuts Available</u></p> <p>*Steel Fascia Angles may be used on corners*</p> <p>External 90° or External 45° Angle      PAINTED</p> <p>Internal 90° or Internal 45° Angle      PAINTED</p> <p>*Colours as per Fascia Cover*</p>	<p>per length</p> <p><b>DURAKOTE</b></p> <p>\$69.89</p> <p>per each</p> <p>\$4.02</p> <p>\$2.49</p>

VALLEY		PRICES EXC
  	<p><b>VALLEY PAINTED - Ribbed</b></p> <p><b>25% Gloss Colours</b>                      Tuscan Red- Slate Grey - Monolith - Ebony</p> <p><u>Stocked Lengths</u>                      4 metre &amp; 6 metre</p>	<p>per metre</p> <p><b>DURAKOTE</b></p> <p>\$24.31</p>
	<p><b>VALLEY PLAIN - Ribbed</b></p> <p>400mm x .38mm TCT</p> <p><u>Stocked Lengths</u>                      3 - 4 - 5 - 6 metres</p> <p>N.B Plain refers to Zinc Aluminium Coated Steel</p>	<p>\$24.34</p>

Barge Soaker



			PRICES EXC GST
  	90mm Half Round Nozzle *Half Round Nozzles are also suitable for Roundline*	PLAIN	\$14.06
	90mm ROUND ASTRAGALS		per each
	90mm Astragals *Colours as per Downpipe*	PAINTED  DURAKOTE	\$2.58
	90mm Astragals N.B Plain refers to Zinc Aluminium Coated Steel	PLAIN	\$2.54
90mm OVERFLOW NOZZLES			per each
90mm Quad Overflow Nozzle	PAINTED	\$33.84	
90mm Half Round Overflow Nozzle	PAINTED	\$33.84	
90mm Roundline Overflow Nozzle *Colours as per downpipe*	PAINTED	\$33.84	
90mm Quad Overflow Nozzle	PLAIN	\$26.14	
90mm Half Round Overflow Nozzle	PLAIN	\$26.14	
90mm Roundline Overflow Nozzle *Orders to be received by 10am*	PLAIN	\$26.14	



## CUSTOM CUTTING SERVICE for 90mm ROUND DOWNPIPE

Ace Gutters can custom cut 90mm Round Downpipe (Plain & Painted) in the following lengths:

SYDNEY	1.8 metres to 7 metres in 0.5m rises
NEWCASTLE	1.8 metres to 7 metres in 0.5m rises
WOLLONGONG	1.8 metres to 7 metres in 0.5m rises
CANBERRA	1.8 metres to 7 metres in 0.5m rises

Please Note:

- (i) Orders must be received by 10am if next day delivery is required.
- (ii) All custom cuts under 20 metres incur a \$25.00 cutting fee – the minimum order metreage is calculated on an individual colour and profile basis – eg an order for 1 x 7m length of 90mm Round Downpipe Hunter Red and 1 x 7m length of 90mm Round Downpipe Brown incurs two minimum cut fees.
- (iii) No returns are accepted on custom cut downpipe.

N.B Plain refers to Zinc Aluminium Coated Steel





# CUSTOM CUTTING SERVICE for 100 x 50mm ROLLFORM DOWNPIPE

Ace Gutters can custom cut 100 x 50mm Rollform Downpipe every weekday - any colour (Plain & Painted) in the following lengths:

<b>SYDNEY</b>	1.8 metres to 7 metres in 0.5m rises
<b>NEWCASTLE</b>	1.8 metres to 7 metres in 0.5m rises
<b>WOLLONGONG</b>	1.8 metres to 7 metres in 0.5m rises
<b>CANBERRA</b>	1.8 metres to 7 metres in 0.5m rises

Please Note:

- (i) Orders must be received by 10am if next day delivery is required.
- (ii) All custom cuts under 20 metres incur a \$25.00 cutting fee – the minimum order metreage is calculated on an individual colour and profile basis – eg an order for 1 x 7m length of 100 x 50mm Rollform Downpipe Hunter Red and 1 x 7m length of 100 x 50mm Rollform Downpipe Brown incurs two minimum cut fees.
- (iii) No returns are accepted on custom cut downpipe.

## 100 X 75MM ROLLFORM DOWNPIPE & COMPONENTS

PRICES EXC GST



### 100 x 75mm ROLLFORM DOWNPIPE PAINTED .45mm TCT

per length

80% Gloss Ace Exclusive Colours

Hunter Red - White - Federation Green - Brown



80% & 25% Gloss Ace Classic Colours

Heritage Red - Smooth Cream - Merino - Jasmin Brown

Slate Grey - Iron Grey

25% Gloss Ace Stylish Colours

Rivergum - Territory - Coventry- Dusk- Off White

Birch - Gull Grey - Armour Grey- Gulf - Manteal

Mist Green -Caulfield Green - Mountain Blue

Basal - Wallaroo - Monolith - Ebony

Stocked Lengths

1.8 metres	PAINTED	\$36.15
2.4 metres	PAINTED	\$48.19
3.6 metres	PAINTED	\$72.30

Custom Cut

1.8 metres to 7 metres in 0.5 metre rises per metre

\*Orders to be received by 10am for next day delivery\* \$20.08

Refer to Page 33 for Custom Cut Days

### 100 x 75mm ROLLFORM DOWNPIPE PLAIN .42mm TCT

per length

Stocked Lengths





1.8 metres	PLAIN	\$30.20
2.4 metres	PLAIN	\$40.26
3.6 metres	PLAIN	\$60.40

Custom Cut

1.8 metres to 7 metres in 0.5 metre rises per metre

N.B Plain refers to Zinc Aluminium Coated Steel \$16.18

100 x 75mm Rollform

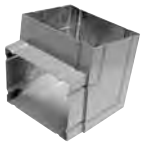
			PRICES EXC GST
*Orders to be received by 10am for next day delivery*			
	ROLLFORM DOWNPIPE NOZZLES		per each
	100 x 75mm Rollform Nozzle	PAINTED	\$9.07
	100 x 75mm Half Round Nozzle	PAINTED	\$15.15
	*Colours as per Downpipe*		
	100 x 75mm Rollform Nozzle	PLAIN	\$7.16
	100 x 75mm Half Round Nozzle	PLAIN	\$14.06
*Half Round Nozzles are also suitable for Roundline*			
	100 x 75mm OVERFLOW NOZZLES		per each
	100 x 75mm Quad Overflow Nozzle	PAINTED	\$33.84
	100 x 75mm Half Round Overflow Nozzle	PAINTED	\$33.84
	100 x 75mm Roundline Overflow Nozzle	PAINTED	\$33.84
	*Colours as per downpipe*		
	100 x 75mm Quad Overflow Nozzle	PLAIN	\$26.14
	100 x 75mm Half Round Overflow Nozzle	PLAIN	\$26.14
	100 x 75mm Roundline Overflow Nozzle	PLAIN	\$26.14
*Custom Spray orders to be received by 10am*			
	ROLLFORM RECTANGULAR ASTRAGALS		per each
	100 x 75mm Rollform Astragals	PAINTED	\$2.51
	*Colours as per Downpipe*		
	100 x 75mm Rollform Astragals	PLAIN	\$2.42
N.B Plain refers to Zinc Aluminium Coated Steel			
	ROLLFORM RECTANGULAR DOWNPIPE OFFSETS ADJUSTABLE		per each
	100 x 75mm Rollform D/Pipe Offset Adjustable LONG	PAINTED	\$72.30
*Colours as per Downpipe*			
	100 x 75mm Rollform D/Pipe Offset Adjustable LONG	PLAIN	\$75.17
	ROLLFORM DOWNPIPE OFFSETS		per each
	100 x 75mm Diecast Offsets	PAINTED	\$13.53
	*Colours as per Downpipe*		
	100 x 75mm Diecast Offsets	PLAIN	\$13.10
*Order (2) to make up offset*			



## CUSTOM CUTTING SERVICE for 100 x 75mm ROLLFORM DOWNPIPE

Ace Gutters can custom cut 100 x 75mm Rollform Downpipe (Plain & Painted) in the following lengths:









SYDNEY	1.8 metres to 7 metres in 0.5m rises
NEWCASTLE	1.8 metres to 7 metres in 0.5m rises
WOLLONGONG	1.8 metres to 7 metres in 0.5m rises
CANBERRA	1.8 metres to 7 metres in 0.5m rises



Please Note:

- (i) Orders must be received by 10am if next day delivery is required.
- (ii) All custom cuts under 20 metres incur a \$25.00 cutting fee – the minimum order metreage is calculated on an individual colour and profile basis – eg an order for 1 x 7m length of 100 x 75mm Rollform Downpipe Hunter Red and 1 x 7m length of 100 x 75mm Rollform Downpipe Brown incurs two minimum cut fees.
- (iii) There are set custom cutting days for each of our colours.
- (iv) No returns are accepted on custom cut downpipe.

N.B Plain refers to Zinc Aluminium Coated Steel

PLEASE REFER TO PAGE 33 FOR COLOUR CUTTING DAYS

NOZZLES			PRICES EXC GST
NOZZLES			per each
	90mm Rollform Nozzle	PAINTED	\$10.04
	90mm Half Round Nozzle	PAINTED	\$15.15
	100 x 50mm Rollform Nozzle	PAINTED	\$7.11
	100 x 50mm Half Round Nozzle	PAINTED	\$15.15
	100 x 75mm Rollform Nozzle	PAINTED	\$9.07
	100 x 75mm Half Round Nozzle	PAINTED	\$15.15
*All Ace Colours*			
	90mm Rollform Nozzle	PLAIN	\$8.48
	90mm Half Round Nozzle	PLAIN	\$14.06
	100 x 50mm Rollform Nozzle	PLAIN	\$4.13
	100 x 50mm Half Round Nozzle	PLAIN	\$14.06
	100 x 75mm Rollform Nozzle	PLAIN	\$7.16
	100 x 75mm Half Round Nozzle	PLAIN	\$14.06
	Uni-Nozzle 85x100x75	PLAIN	\$9.19
OVERFLOW NOZZLES			per each
	Quad Overflow Nozzle	PAINTED	\$33.84
	Half Round Overflow Nozzle	PAINTED	\$33.84
	Roundline Overflow Nozzle	PAINTED	\$33.84
*All Ace Colours* *Custom Spray orders to be received by 10am*			
	Quad Overflow Nozzle	PLAIN	\$26.14
	Half Round Overflow Nozzle	PLAIN	\$26.14
	Roundline Overflow Nozzle	PLAIN	\$26.14
Available in 90mm, 100x50mm and 100x75mm			

RAINWATER HEADS			PRICES EXC GST
RAINWATER HEADS			per each
	Standard Rainwater Head	PAINTED & PLAIN	\$167.19
*All Ace Colours*			
Nozzles to suit 50 - 65 - 90 - 100 - 100 x 50 - 100 x 75 - 100 x 100mm (not included in price)			
	Small Rainwater Head	PAINTED & PLAIN	\$127.08
	ACE LEAF DIVERTER <sup>®</sup>	NETT	
	Ace Leaf Diverter <sup>®</sup>	PAINTED	\$33.52
*All Ace Colours*			
	Ace Leaf Diverter <sup>®</sup>	PLAIN	\$27.09
Available in 90mm, 100x50mm and 100x75mm			

# OFFSETS FOR ROLLFORM DOWNPIPE

Available in 100 x 50mm & 100 x 75mm

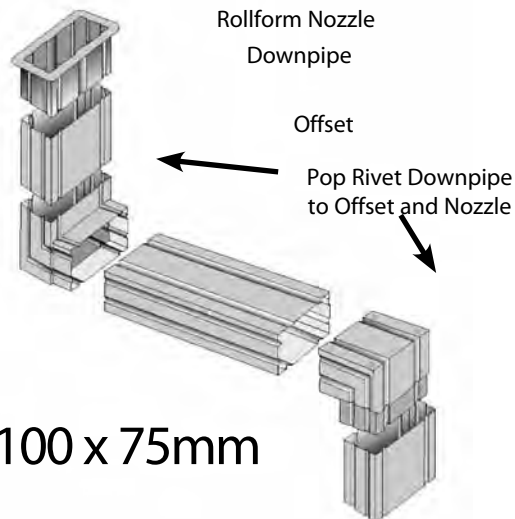

ACCESSORIES				PRICES EXC GST
	POP RIVETS			per packet
	1/8 Pop Rivets	PKT 100	COLOURED	\$8.27
	1/8 Pop Rivets	PKT 1000	COLOURED	\$35.19
	1/8 Pop Rivets	PKT 100	ALUMINIUM	\$7.95
	1/8 Pop Rivets	PKT 1000	ALUMINIUM	\$33.83
	Pop Rivet Gun (NETT)			\$13.24
	Pro Pop Rivet Gun (NETT)			\$45.47
	SCREWS			per packet
	Rafter Screws	6# X 25MM	PKT 100	\$6.29
	Rafter Screws	6# X 25MM	PKT 1000	\$20.11
	Self Drilling Screws	8# X 16MM	PKT 100	\$14.75
	Self Drilling Screws	8# X 16MM	PKT 1000	\$34.51
	Self Drilling Screws Premium Class 4		PKT 100	\$10.33
Self Drilling Screws Premium Class 4		PKT 1000	\$97.80	
	NAILS & NAIL HOLDER		(NETT)	per each
	40mm Twist Gutter Nails		500G PACKET	\$6.76
	40mm Twist Gutter Nails		2KG PACKET	\$26.27
	40mm Twist Gutter Nails		5KG PACKET	\$60.62
	Nail Holder			\$15.59
	T-socket Spanner		(NETT) 150gm	per each \$21.89
	TOUCH UP PAINT		(NETT) 150gm	per each \$13.90
	Touch Up Spray Cans		150gm	\$13.90
	*All Colours*			
*Ace Gutters Pty Ltd takes no responsibility if spray is used on Painted Steel*				
	SEALERS & GUNS (NETT)		Exc GST	per each
	Sealer 300g Cylinder	Grey-Clear	SINGLE	\$6.48
	Sealer 300g Cylinder	Grey-Clear	5 Tubes	\$26.50
	Sealer 300g Cylinder	Grey-Clear	Carton of 20	\$99.40
	Sealer 300g Cylinder	Grey-Clear	10 Cartons of 20	\$766.00
	Sealer 300g Cylinder	Grey-Clear	50 Cartons of 20	\$3,830.00
	Caulking Gun Heavy Duty Pro Silicon Gun			*12 month Shelf Life*
	PHILLIPS BITS		(NETT)	per each
	200mm Phillips Bits		LONG	\$9.64
	65mm Phillips Bits		SHORT	\$3.37
	DRILL BITS		(NETT)	
	1/8 Double Ended Drill Bits		EACH	\$1.81
	1/8 Double Ended Drill Bits		PKT 10	\$18.15
	NAIL IN PLUGS		(NETT)	per packet
	5mm x 25mm Nail In Plugs		PKT 100	\$6.25
	6.5mm x 38mm Nail In Plugs		PKT 100	\$11.46
	MISCELLANEOUS TOOLS		(NETT)	per each
	Pro Snips L/hand Red			\$28.83
	Pro Snips R/hand Green			\$28.83
	Pro Snips Straight Yellow			\$28.83
	Offset Snips L/hand Red			\$27.21
	Offset Snips R/hand Green			\$27.21
	Packet 10 Hacksaw Blades			\$20.54
	Nylon Bricklayers Line		50 metres	\$7.56
	Tape Measure 8 metre fluoro			\$8.00
	Handy Bar			\$17.92
Hacksaw			P.O.A.	

	<b>LEAFGUARD METAL</b>			per length	
	Nu-Line	155mm x 2500mm		PAINTED	\$45.29
	Mini-Line	130mm x 2500mm		PAINTED	\$35.19
	Quad/Square-line	120mm x 2500mm		PAINTED	\$33.75
	Half Round (pkt brackets supplied)	155mm x 2500mm		PAINTED	\$59.55
	Roundline	155mm x 2500mm		PAINTED	\$45.30
	<u>Colours</u>				
	Mountain Blue - Slate Grey - Ebony				
	Nu-Line	155mm x 2500mm		PLAIN	\$36.27
	Mini-Line	130mm x 2500mm		PLAIN	\$28.49
Quad/Square-Line	120mm x 2500mm	PLAIN	\$27.52		
Half Round (pkt brackets supplied)	155mm x 2500mm	PLAIN	\$50.21		
Roundline	155mm x 2500mm	PLAIN	\$36.28		
*Concealed brackets may be needed to support leafguard*					
	<b>PLASTIC BLACK DOWNPIPE TEMPORARY</b>		(NETT)	per roll	
	100 metre			\$35.39	
	<b>NEW LEAFGUARD RANGE</b>			per length	
	Manufactured from expanded steel – the product is powder coated (.55 / G300 material) and is CSIRO fire rated to 0 / non combustible				
	Quad External Bracket	1.2 m		\$27.37	
	Quad Internal Bracker	1.2 m		\$27.37	
	Half Round	1.2 m		\$27.37	
	Roundline	1.2m		\$27.37	
	Corrugated	1.2m		\$44.03	
	Valley Tile	1.2m		\$44.03	
	Valley Metal	1.2m		\$44.03	
	Step Leafguard	1.2m		\$44.03	
All profiles are stocked 1.2m lengths in Gull Grey					
All industry colours are available on a custom cut basis (48 hour lead time) - minimum					
Other profiles can be custom made as per your drawings (48 hour lead time) - minimum					
	<b>GUTTER SPACERS</b>		*** NEW PRODUCT***	per each	
	5mm Gutter Spacer		Pkt 10	\$41.29	
	10mm Gutter Spacer		Pkt 10	\$49.20	
	5mm External Angle Gutter Spacer		Pkt 10	\$26.24	
	10mm External Angle Gutter Spacer		Pkt 10	\$33.48	
	5mm Internal Angle Gutter Spacer		Pkt 10	\$26.24	
	10mm Internal Angle Gutter Spacer		Pkt 10	\$33.48	
	Suspension Clip Spacer		Pkt 10	\$23.63	

Accessories



**\*\*\* NEW PRODUCT \*\*\***  
**ACE GUTTERS**  
**OVERFLOW SPACER RANGE**

***“The viable overflow alternative”***

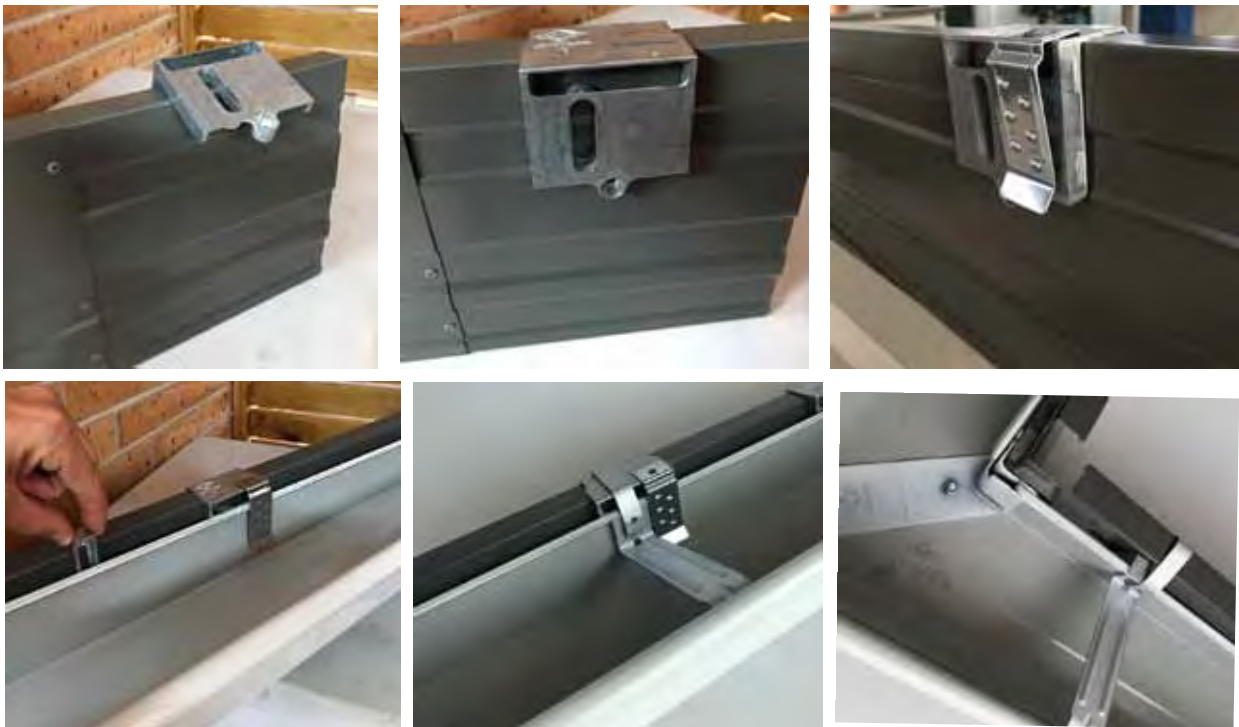

***To ensure absolute overflow prevention and to avoid potential damage to your roof or home as a result of heavy rainfall. The Ace Gutters Spacer Range offers a viable overflow alternative.***

- The Ace Gutters Spacer is available in 10mm Clip and 5mm Clip.  
**Please Note** the 10mm Clip is compliant to the Australian Standards whereas the 5mm clip will need to be installed as an alternative solution. (Refer to installation advice overleaf).
- This simple to install SPACER clip provides a consistent gap between the gutter and fascia which allows water to escape in the event of any blockage in your guttering
- Aesthetically the gap cannot be seen from the ground or at street level
- The SPACER clip is manufactured from zinc alloy hence non corrosive
- The SPACER clip contains a snap off clip which is then installed between all spacers installed providing a consistent gap around your home.
- The Ace Gutters SPACER clip is a cost effective way to prevent water ingress into your home in the event of heavy rain.

\*\*\*all products sold within the SPACER range are sold in packets of 10\*\*\*

See Page 27 for Prices

# PREMIUM PRODUCTS

## \*NOW AVAILABLE\*

Durakote® Coastal Painted Steel for Severe Coastal & Industrial Environments.

### AVAILABLE IN:

Ace Quad  
Half Round Gutter  
Roundline Gutter  
Steel Fascia

### AVAILABLE IN SIX STUNNING AUSTRALIAN LANDSCAPE COLOURS:







Slate Grey 25% low gloss  
Off White 25% low gloss  
Birch 25% low gloss  
Armour Grey 25% low gloss  
Wallaroo 25% low gloss  
Monolith 25% low gloss

Environment	Coastal
Severe coastal (100m-200m from breaking surf)	<input checked="" type="checkbox"/>
Severe industrial (100m-200m from source of industrial emmission)	<input checked="" type="checkbox"/>





# PREMIUM ACCESSORIES

To complement the Premium Product range Ace Gutters have introduced a range of Premium Accessories. These accessories are diecast zinc components which are conversion coated with chromate, chemically cleaned and then primed using Interpon MetaPrep™ Gold, a powder coating treatment designed as a barrier primer and surfacer for chemical and salt spray resistance. Powdered paint is applied as a top coat which is then oven baked onto the product resulting in a quality finish that ensures maximum durability in severe coastal and industrial environments.

**COASTAL ACE QUAD GUTTER & ACCESSORIES**
**PRICES EXC GST**

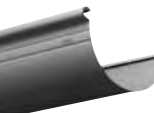
	<p>COASTAL PAINTED ACE QUAD GUTTER - 115mm                  25% Gloss Colours                  Slate Grey - Armour Grey - Off White                  Birch - Wallaroo - Monolith</p> <p style="text-align: right;"></p> <p><u>Custom Cut Only</u>                  2 metres to 12 metres in 0.5 metre rises                  *Orders to be received by 10am* *All Colours available*                  *Custom cut every weekday*</p>	per metre         \$23.83																				
	<p>COASTAL PAINTED ACE QUAD STOP ENDS                  *Colours as per Gutter* *Stock Item*</p> <p style="text-align: right;"></p>	per pair \$8.85																				
	<p>PREMIUM FEATURE ACE QUAD ACCESSORIES                  External 90° or External 45° Angle                  Internal 90° or Internal 45° Angle                  *Colours as per Gutter* *Not stocked - Custom Spray - orders to be received by 10am                  *Premium refers to product being specially pre-treated*</p> <p style="text-align: right;">PREMIUM                  PREMIUM</p>	per each \$29.74 \$29.74																				
	<p>PAINTED ACE QUAD ACCESSORIES</p> <table border="0"> <tr> <td>Concealed Bracket</td> <td>Plain</td> <td>PKT 10</td> <td>PAINTED</td> </tr> <tr> <td>Overstrap Bracket</td> <td>Plain</td> <td>PKT 10</td> <td>PAINTED</td> </tr> <tr> <td>Concealed Suspension Bracket</td> <td>Plain</td> <td>PKT 10</td> <td>PAINTED</td> </tr> <tr> <td>Metal Fascia Suspension Clips</td> <td>Plain</td> <td>PKT 10</td> <td>PAINTED</td> </tr> <tr> <td>Timber Fascia Suspension Clips</td> <td>Plain</td> <td>PKT 10</td> <td>PAINTED</td> </tr> </table> <p>*Painted refers to plain steel that has been painted plain* *Not stocked - Custom Spray</p>	Concealed Bracket	Plain	PKT 10	PAINTED	Overstrap Bracket	Plain	PKT 10	PAINTED	Concealed Suspension Bracket	Plain	PKT 10	PAINTED	Metal Fascia Suspension Clips	Plain	PKT 10	PAINTED	Timber Fascia Suspension Clips	Plain	PKT 10	PAINTED	per pack \$20.27 \$29.83 \$54.12 \$30.67 \$33.74
Concealed Bracket	Plain	PKT 10	PAINTED																			
Overstrap Bracket	Plain	PKT 10	PAINTED																			
Concealed Suspension Bracket	Plain	PKT 10	PAINTED																			
Metal Fascia Suspension Clips	Plain	PKT 10	PAINTED																			
Timber Fascia Suspension Clips	Plain	PKT 10	PAINTED																			

**COASTAL HALF ROUND GUTTER & ACCESSORIES**
**PRICES EXC GST**

	<p>COASTAL PAINTED HALF ROUND GUTTER - 150mm                  25% Gloss Colours                  Slate Grey - Armour Grey - Off White                  Birch - Wallaroo - Monolith</p> <p>Available in <u>SLOTTED</u> or <u>UNSLOTTED</u></p> <p><u>Custom Cut Only</u>                  2 metres to 10 metres in 0.5 metre rises                  *All colours are available custom cut every weekday*                  *Orders to be received by 10am*</p> <p style="text-align: right;"></p>	per metre         \$28.75
	<p>COASTAL PAINTED HALF ROUND STOP ENDS                  *Colours as per Gutter* *Not stocked - Custom Spray - orders to be received by 10am</p> <p style="text-align: right;"></p>	per pair \$22.32
	<p>PREMIUM FEATURE HALF ROUND ACCESSORIES                  External 90° or External 45° Angle                  Internal 90° or Internal 45° Angle                  External Bracket Half Round                  *Colours as per Gutter* *Not stocked - Custom Spray                  *Premium refers to product being specially pre-treated*                  * N.B Coastal accessories are not stocked &amp; must be ordered by 10am</p> <p style="text-align: right;">PREMIUM                  PREMIUM                  PKT 5                  PREMIUM</p>	per each \$44.94 \$44.94 \$96.07

**\* All Custom Cuts under 20 metres incur a \$25.00 cutting fee. The minimum order metreage is calculated on an individual colour and profile basis.**

COASTAL ROUNDLINE GUTTER & ACCESSORIES				PRICES EXC GST	
	COASTAL PAINTED ROUNDLINE GUTTER - 150mm <u>25% Gloss Colours</u> Slate Grey - Armour Grey - Off White  Birch - Wallaroo - Monolith  Available in <u>SLOTTED</u> or <u>UNSLOTTED</u> <u>Custom Cut Only</u> 2 metres to 10 metres in 0.5 metre rises *All colours are available custom cut every weekday* *Orders to be received by 10am*				per metre         \$28.75
	COASTAL PAINTED ROUNDLINE STOP ENDS *Colours as per Gutter* *Not stocked - Custom Spray - orders to be received by 10am				per pair  \$22.32
	PREMIUM FEATURE ROUNDLINE ACCESSORIES External 90° or External 45° Angle Internal 90° or Internal 45° Angle  *Colours as per Gutter* *Not stocked - Custom Spray - orders to be received by 10am *Premium refers to product being specially pre-treated*			PREMIUM PREMIUM	per each \$44.94 \$44.94
	PAINTED ROUNDLINE ACCESSORIES Overstrap Bracket Plain PKT 10 PAINTED Concealed Suspension Bracket Plain PKT 10 PAINTED Metal Fascia Suspension Clip Plain PKT 10 PAINTED Timber Fascia Suspension Clip Plain PKT 10 PAINTED  *Painted refers to plain steel that has been painted plain* *Not stocked - Custom Spray				per pack \$33.94 \$54.13 \$30.67 \$33.74

**COASTAL STEEL FASCIA & ACCESSORIES** PRICES EXC GST

	<u>25% Gloss Colours</u> Slate Grey - Armour Grey - Off White  Birch - Wallaroo - Monolith  <u>Custom Cut Only</u> 3 metres to 9.5 metres in 0.5m rises *Orders to be received by 10am* *All Colours available* *Custom cut every weekday*				
	COASTAL PAINTED STEEL FASCIA ACCESSORIES External 90° or External 45° Angle Internal 90° or Internal 45° Angle Internal Joiner Steel Fascia Barge Apex Cover Barge Moulds Pair (RH & LH) *Stock Item*			COASTAL COASTAL COASTAL COASTAL COASTAL	per each \$5.42 \$3.36 \$6.19 \$6.83 \$10.87 *Colours as per Gutter*
	PAINTED STEEL FASCIA ACCESSORIES Standard Rafter Brackets Plain PKT 10 PAINTED Hip Rafter Brackets Plain SINGLE PAINTED Barge Rafter Brackets Plain PKT 10 PAINTED 90° Barge Rafter Bracket Plain PKT 10 PAINTED Metal Fascia Suspension Clips Plain PKT 10 PAINTED  *Painted refers to plain steel that has been painted plain* * N.B Coastal accessories are not stocked & must be ordered by 10am				\$38.60 \$3.87 \$37.92 \$38.60 \$30.67

Ultra/Coastal

ACCESSORIES		PRICES EXC GST	
	Self Drilling Screws Premium Class 4	PKT 100	\$9.21
	Self Drilling Screws Premium Class 4	PKT 1000	\$87.13
	Phillips Bits	LONG (NETT)	\$9.03
	Phillips Bits	SHORT (NETT)	\$3.16



Ultra/Coastal



**WE DON'T JUST SELL GUTTERS**  
**NOW AVAILABLE**



**DURAKOTE**

**CORRY ROOFING**  
**ACEDEK ROOFING**  
**ROLL TOP RIDGE**  
**NON RIBBED VALLEY**  
**ROOF BATTENS**  
**BLANKETS**  
**ROOFING SCREWS**

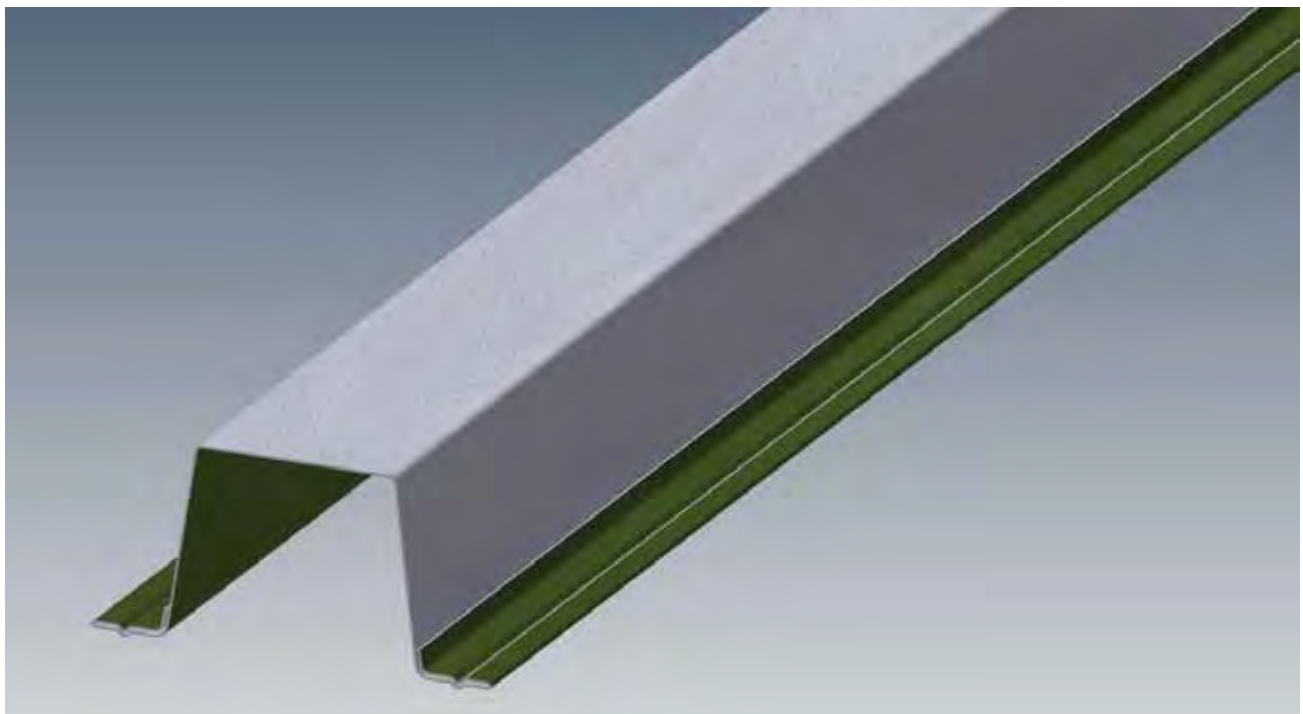

# DIMENSIONS OF OUR PRODUCTS

Dimensions

### Nu-Line

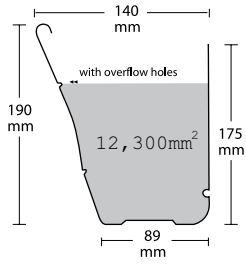

### Nu-Line Metal Roof

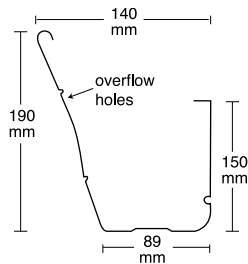

### Mini-Line

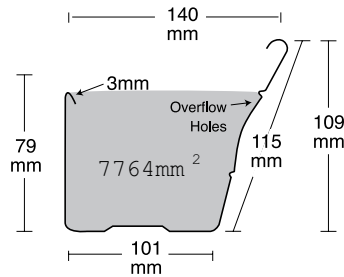

### Old Style Quad

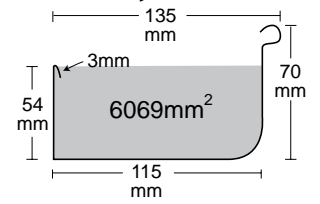

### Roundline Unslotted

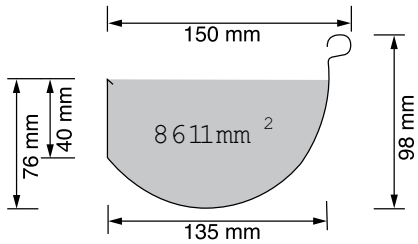

### Roundline Slotted

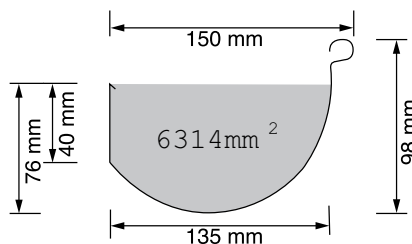

### Ace Quad

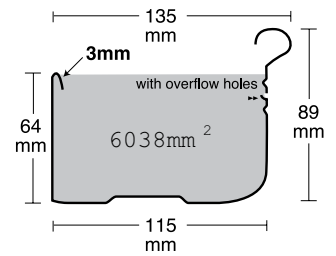

### Half Round Unslotted

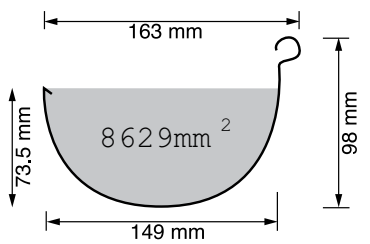

### Half Round Slotted

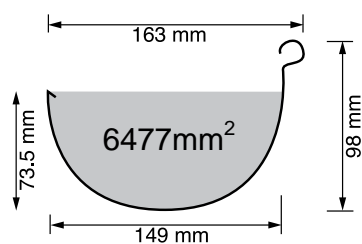

### Fascia Cover

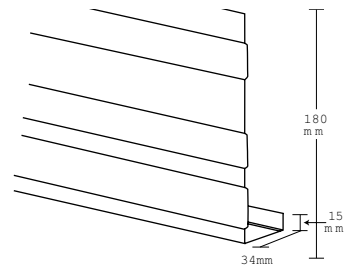

### Steel Fascia

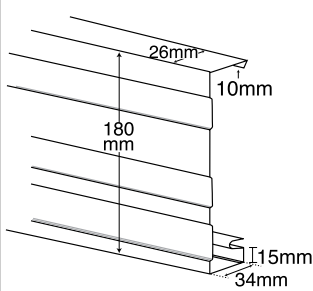

### Valley

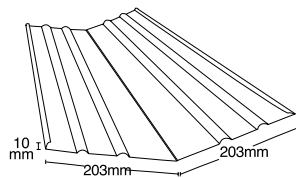

### Rainwater Head

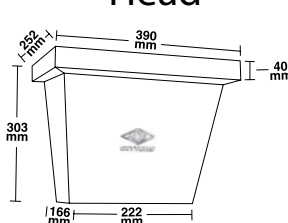

### Square-Line

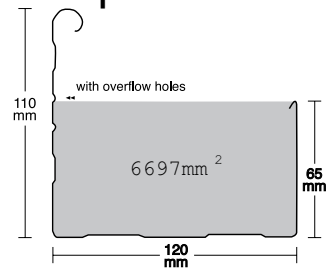

### Leaf Diverter

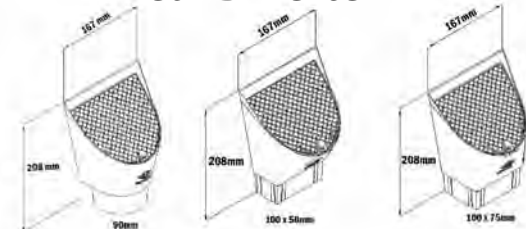

### Barge Soaker

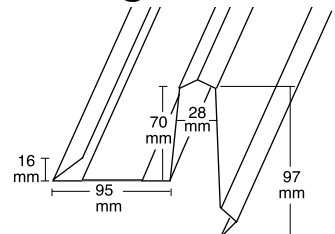

### Capping

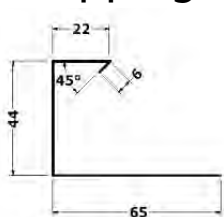

### Concealed



### Soaker Flashing

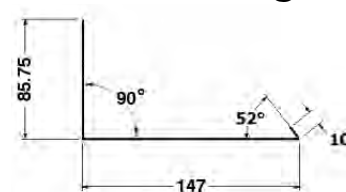

# COMPATABILITY CHART (DISSIMILAR METALS)

## ROOF MATERIAL

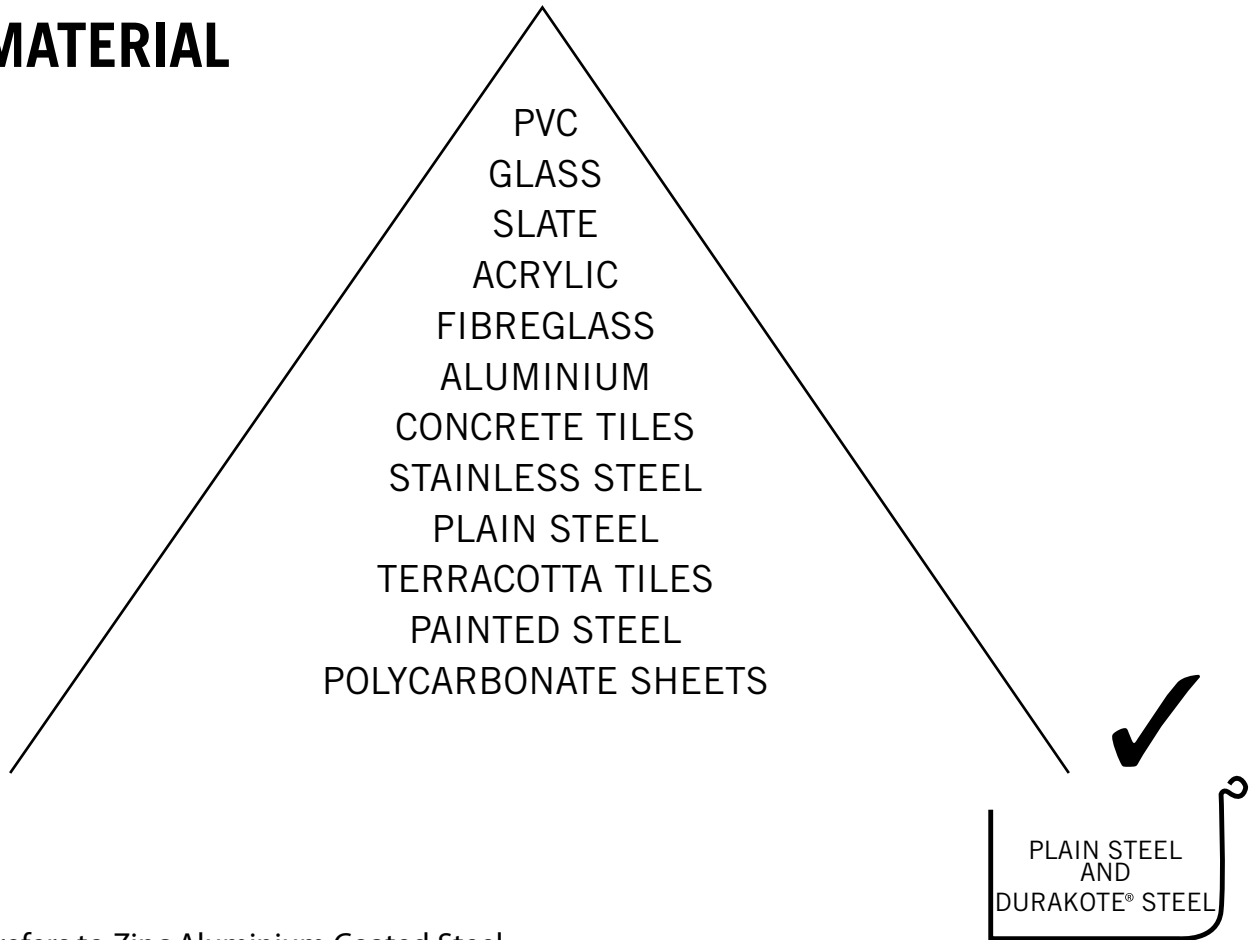

N.B Plain refers to Zinc Aluminium Coated Steel

Compatibility

## Compatibility of Direct Contact between Metals and Alloys

ACCESSORY FASTENER MATERIAL	CLADDING MATERIAL		
	Zinc aluminium coated (plain steel)	Durakote®	Ultra/Coastal
STAINLESS STEEL	No	No	No
ZINC ALUMINIUM COATED STEEL	Yes	Yes	Yes
ALUMINIUM	Yes	Yes	Yes
COPPER & BRASS	No	No	No
LEAD	No	No	No

*“ Do not use Lead or Copper with Plain Steel ”*

# ACE GUTTERS DELIVERY SERVICE

## Warehouse & Distribution Manager

GEOFF HARMEY

Phone: (02) 9584 4750

Fax:(02) 9584 4799

## Operations Manager Warehouse

SHAUN CALDWELL

Phone: (02) 9584 4749

Fax: (02) 9584 4799

## Sales Office Manager

DANIEL BORG

Phone: (02) 9584 4752

Fax: (02) 9584 4799

Email: [sales@acegutters.com.au](mailto:sales@acegutters.com.au)

## IMPORTANT DELIVERY INFORMATION FOR SYDNEY METROPOLITAN & SURROUNDING AREAS SOUTH COAST ACT/CANBERRA Deliveries for gutter lengths up to and including 12.0m

Ace Gutters offers a DAILY delivery day service into the Sydney metropolitan area for Rainwater Goods and Plumbing Supplies.

All orders received by 5am on any weekday (for stocked items) can be delivered same day if requested. (Account Customers only)

There are set delivery days for suburbs located on the outskirts of the Sydney metropolitan area – these suburbs are listed below:

### WEST

Mon-Wed-Fri

Blaxland

Faulconbridge

Glenbrook

Springwood

Winmalee

Tuesday

West of Springwood to Bathurst.

### SOUTH WEST

Mon-Wed-Fri

Menangle

Picton

Thirlmere

Tahmoor

Buxton

Bargo

### NORTH WEST

Mon-Wed-Fri

Kurrajong

Ebenezer

Tue-Thurs

Glenorie

Cattai

Maralya

Arcadia

### SOUTH COAST

DAILY

Helensburgh

Stanwell Tops

Kiama

South of Kiama

to Nowra

Delivery

Also refer to the adjoining map. This map shows our delivery border for the Sydney Metropolitan area.

## FEES & CHARGES

- (i) All Delivered orders incur a delivery fee per order of \$15.00. Returned Goods collected by Ace Gutters incur a \$110 pickup fee and orders must have a minimum product value of \$100 exc GST.
- (ii) Orders under the product value of \$150.00 exc GST incur an additional \$25.00 minimum delivery fee.
- (iii) Any approved delivery outside delivery borders incurs a \$110.00 delivery fee.
- (iv) If special packaging is required a fee of \$1.10 per metre is charged – minimum charge \$11.00 maximum charge \$100.00.
- (v) Minimum payment by credit card is \$10.00.

PLEASE NOTE: GST IS APPLICABLE ON ALL FEES

# IMPORTANT DELIVERY INFORMATION FOR BLUE MOUNTAINS - BATHURST & DELIVERY POINTS ALONG THE ROUTE

Deliveries for gutter lengths up to and including 12.0m

Ace Gutters offers a set delivery day service to Bathurst, NSW and various points along the Great Western Highway for Rainwater Goods and Plumbing Supplies.

The Maximum length delivered into the Blue Mountains/Bathurst and surrounding areas is 12 metres.

All Email, Fax and Phone orders MUST be received at Ace Gutters by 10am on the day before delivery. Please note the order lines will be open until 2pm should you require the inclusion of a late order (stock items only). However, this late order facility does not guarantee next day delivery.

Please note for delivery of Rainwater or Plumbing Goods in Orange and surrounding areas, orders can be placed via our rollforming agent The Lindfield Group (please see contact details below.

## TUESDAY

Blue Mountains

Hartley

Lithgow

Wallerawang

Kelso

Bathurst

## CONTACT DETAILS

Ace Gutters - 02 9584 4750

Sales Contact - Geoff Harmey

The Lindfield Group - 02 6360 1136

Sales Office



# SYDNEY & SOUTH COAST

## DELIVERY SCHEDULE

**FOR RAINWATER GOODS 12 METRES AND UNDER PLUS PLUMBING SUPPLIES**

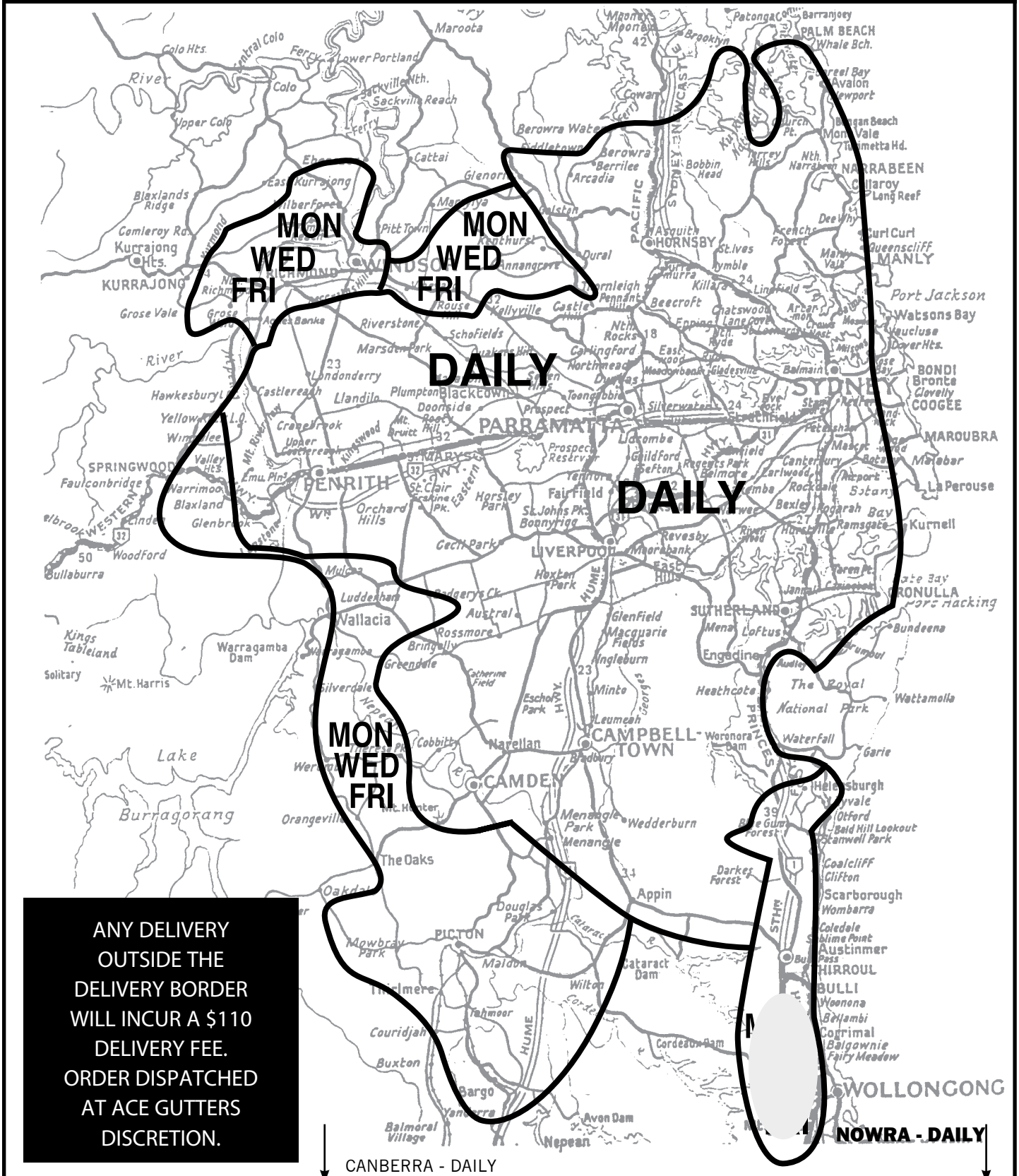

ANY DELIVERY OUTSIDE THE DELIVERY BORDER WILL INCUR A \$110 DELIVERY FEE. ORDER DISPATCHED AT ACE GUTTERS DISCRETION.

Delivery

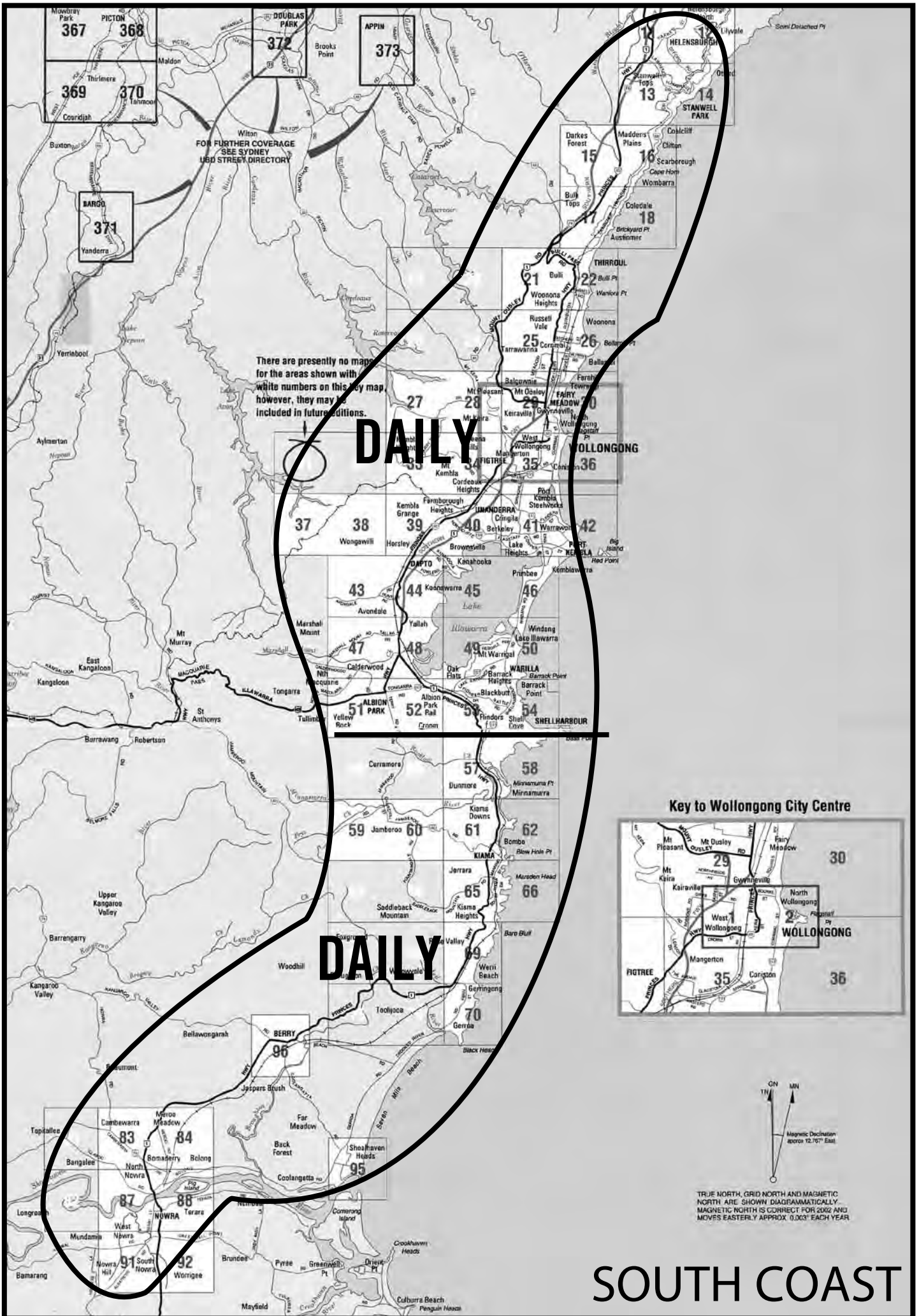

# SOUTH COAST

“ 80% Gloss on Most Products ”

# IMPORTANT DELIVERY INFORMATION FOR ACT/CANBERRA & SURROUNDING AREAS

Deliveries for gutter lengths up to and including 12.0m

Ace Gutters offers DAILY delivery service for Rainwater Goods and Plumbing Supplies to the Goulburn/Canberra Area.

All email, fax and phone orders MUST be received by 3pm the day before delivery.

Please note the order lines will be open until 4pm should you require a late order facility however, this late order facility does not guarantee next day delivery.

Custom cut orders MUST be received by 10am the day before delivery.

## ACE GUTTERS PTY LTD

A.B.N. 49 001 885 276

69 Boundary Road Mortdale NSW 2223

Phone Orders: (02) 9584 4788 Fax Orders: (02) 9584 4799

Email orders: [sales@acegutters.com.au](mailto:sales@acegutters.com.au)

ACT AREA MANAGER

Joe Marando

Phone: 0439 245 201 Fax: (02) 6238 1380

### NO RESPONSIBILITY

will be taken if painted metal surfaces come in contact  
with ACID when cleaning brickwork

Please advise acid wash contractors to wash off and rinse with clean water  
all Fascia, Gutter, Downpipes, Windows and Steel Doors.

**DO NOT USE LEAD OR  
COPPER WITH PLAIN STEEL**

**PLEASE PASS THIS INFORMATION ON TO YOUR BUILDER**

# CANBERRA

Delivery

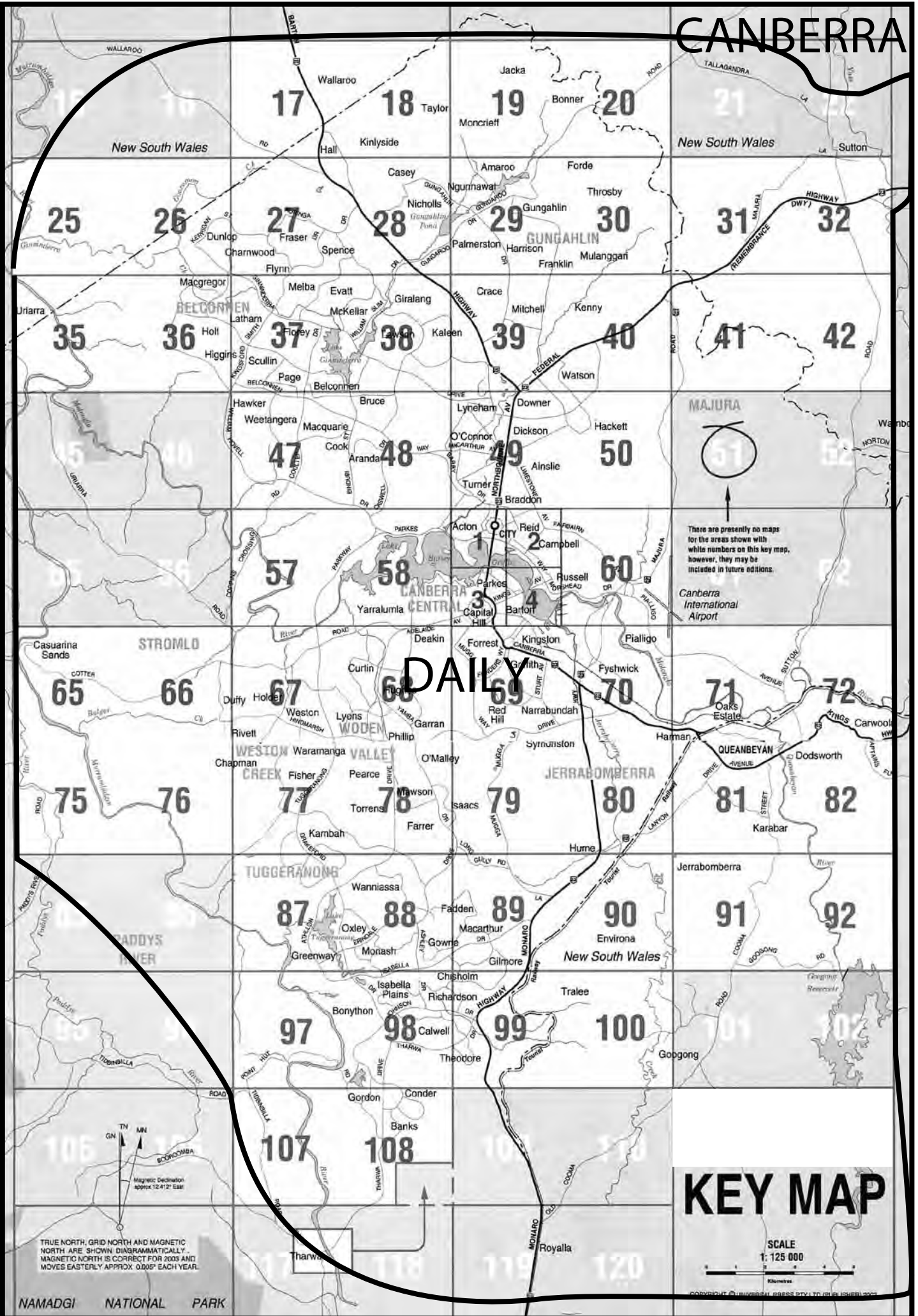

DAILY

KEY MAP

SCALE 1:125 000

TRUE NORTH, GRID NORTH AND MAGNETIC NORTH ARE SHOWN DIAGRAMMATICALLY. MAGNETIC NORTH IS CORRECT FOR 2003 AND MOVES EASTERLY APPROX. 0.005° EACH YEAR.

“ Custom Cutting of Nu-Line, Mini-Line & Quad Gutters ”

# IMPORTANT DELIVERY INFORMATION FOR NEWCASTLE/CENTRAL COAST & SURROUNDING AREAS

Deliveries for gutter lengths up to and including 12.0m

Ace Gutters offers a set delivery day service into the Newcastle/Central Coast area for Rainwater Goods and Plumbing Supplies.

The Maximum length delivered into the Newcastle/Central Coast and surrounding areas is 12 metres.

All Email, Fax and phone orders **MUST** be received by 3pm on the day before delivery.

Please note the fax line will be open until 4pm should you require a late order facility however, this late order facility does not guarantee next day delivery.

The set delivery days are listed below:

<b>DAILY</b>	<b>MON &amp; WED</b>	<b>WEDNESDAY</b>	<b>FRIDAY</b>
Gosford	Nelson Bay	Karuah	City & South
Central Coast	Medowie	Tea Gardens	Area of Branxton
Lake Macquarie		Hawks Nest	Singleton
Cessnock (except Wed)			
Maitland			
Newcastle Metropolitan			
Raymond Terrace			

\* For delivery requirements north of Hawks Nest/Tea Gardens please contact our distribution manager, Geoff Harmey on 02 9584 4750

PLEASE NOTE THE ADJOINING AREAS NOT LISTED WILL BE IN  
CONJUNCTION WITH SPECIFIED DAYS

## ACE GUTTERS PTY LTD

A.B.N. 49 001 885 276

69 Boundary Road Mortdale NSW 2223

Email orders: [sales@acegutters.com.au](mailto:sales@acegutters.com.au)

Newcastle Phone: (02) 4948 6611 Fax: (02) 4948 9543

Diverted to SYDNEY TOLL FREE



# NEWCASTLE DELIVERY SCHEDULE

FOR RAINWATER GOODS & PLUMBING SUPPLIES

\* Maximum length delivered into the NEWCASTLE/CENTRAL COAST & Surrounding areas is 12.0m\*

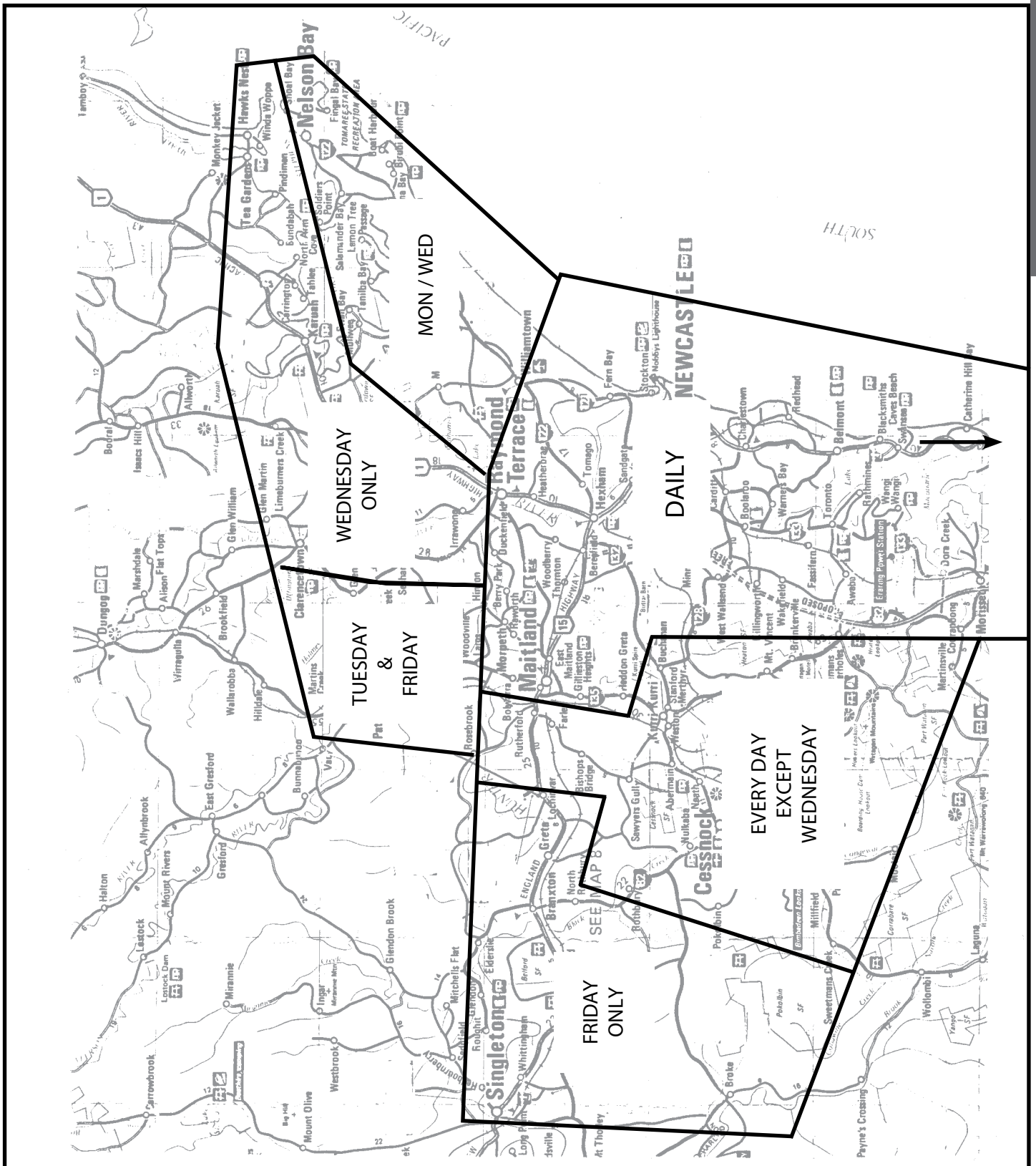

Delivery

“ Covering All Metropolitan Areas ”

# ACE COLOURS REFERENCE GUIDE

## ACE REVISED COLOUR NAMES

### ACE EXCLUSIVE COLOURS

Hunter Red

White

Federation Green

Brown

Rivergum

### ACE CLASSIC COLOURS

Heritage Red

Smooth Cream

Merino

Jasmin Brown

Slate Grey

Iron Grey

### ACE STYLISH COLOURS

Territory

Coventry

Dusk

Off White

Birch

Gull Grey

Armour Grey

Gulf

Manteal

Mist Green

Caulfield Green

Mountain Blue

Basal

Wallaroo

Monolith

Ebony

## TERMS AND CONDITIONS OF SALE

In these Terms and Conditions, Company means Ace Gutters Pty Ltd and customer means the purchaser of goods from the Company.

### 1. Payment Terms

Payment Terms are net 35 days from the end of the month in which goods are purchased.

### 2. Discount for Prompt Payment

A 2% settlement discount may be claimed by the customer at the time of payment where full payment of the account (including payment of disputed credit claims) is received strictly within the 35 day credit terms. Discount does not apply to credit card payments.

### 3. Interest on Overdue Accounts

Interest may be charged on the outstanding balance of the account not paid for by the due date in accordance with the interest rate specified by the Supreme Court Rules.

### 4. Delivery

a. Times not Guaranteed. Any times estimated for delivery and installation are estimates only and the Company shall not be liable for failure to deliver or install or for delay in delivery or installation arising from any cause whatsoever.

b. No Responsibility for Goods once Delivered. Goods may be delivered to a site nominated by the customer and the customer is responsible for the security and condition of goods left immediately after delivery whether or not a representative of the customer or any other person is present to receive delivery.

c. Offset for Delay Not Allowed. The customer shall not be entitled to withhold payment or any part thereof by reason of delay in delivery or despatch of goods.

d. Delivery may be Part only. The Company reserves the right to deliver a portion only of an order and such delivery shall not entitle the customer to cancel or repudiate the order.

### 5. Goods held by the Company

Goods ordered for collection or asked to be manufactured "until advised" will be held for a maximum period of 20 working days after the specified date. The goods will then at the discretion of the Company be either delivered to the Customers premises or to a depot selected by the Company for the Customer to collect at a later date at the Customers expense. All additional costs (including damage or storage) incurred by the Company as a result of holding material for longer than the maximum 20 days will be charged to the Customer account and shall be payable by the Customer.

### 6. Legal Costs Recoverable

The customer will be responsible for ALL legal costs incurred by the Company in the recovery of any overdue amount.

### 7. Limitations of Liability

Subject to such rights of the customer as may necessarily be preserved by state or federal legislation, no claim by the customer for poor workmanship or failure to supply products conforming to the customer's order shall be recognised by the Company unless made in writing to the Company within 14 days after delivery of the goods to the customer. No claim involving labour charges or product replacement will be recognised by the Company unless the Company's agreement to the value of such claim is obtained immediately such a problem becomes evident and that customer demonstrates that they have taken all possible action to minimise the effect of such claim and that the Company is given sufficient time to investigate and take any action it feels necessary to resolve the problem. No claims will be recognised by the Company relating to materials which have been fixed unless in the Company's view the problem could not have been detected during the fixing process. Claims for "lost time" or "waiting time" will not be accepted by the Company. No claim will be recognised by the Company for any loss, damage or injury of any kind whatsoever arising directly or indirectly from the customer's failure to obtain independent professional and / or tradesman's advice in relation to the suitability of the goods for any specific purpose. The Company shall not be liable to the customer for any loss of profits or consequential, indirect or special loss, damage or injury of any kind whatsoever, arising directly or indirectly from any defect in the goods or their installation (regardless of any express or implied terms, or by reason of the Company's negligent act or omission or otherwise at common law).

### 8. Return of Goods

a. Stock items. Stock items only may be returned for credit, they must be returned within 14 days of delivery and have a minimum product value of \$100 exc GST.

b. Re-stocking fee and Cartage. A 30% Restocking fee will apply on all standard products returned.

c. Pick Up Fee. A \$100 plus GST fee will apply on goods collected by Ace Gutters. The minimum product value of goods that will be collected is \$100 exc GST.

d. Invoice number must be quoted. On returning goods the original invoice number on which they were supplied must be provided.

e. Plain Nu-Line Returns. Plain Nu-Line will only be accepted for return at the Company's discretion.

f. Products not returnable unless defective. Painted Product and downpipes will not be accepted for credit unless faulty or damaged at time of delivery or wrong product delivered.

### 9. Fitness for Purpose and Defective Installation – No Warranty

The company shall not be liable for any:

a. representation, promise or undertaking regarding the fitness or otherwise of goods or service supplied by the Company unless it is made in writing or implied by law,

or

b. failure by the customer to fix, install or erect the goods in accordance with any advice, recommendation, specification, information, assistance or service provided by the Company in relation to goods sold or manufactured by it. The performance of steel products is dependent on the environment, product selection, handling, installation and maintenance.

### 10. Withholding Delivery in case of Suspected Insolvency

The Company may withhold delivery of any goods ordered or purchased by the customer (and may refuse further credit) where the customer is overdue in its account or where the Company suspects for any reason that the customer may not be able to pay its debts as they fall due.

### 11. Quotes

The following additional conditions apply to goods ordered pursuant to a quotation from the Company:

a. Availability. All quotations are subject to the goods being available to the Company from its own suppliers.

b. Rise and Fall of Copper. All prices for copper products are subject to rise and fall in the market price of copper.

c. Price. Prices quoted are based on the Company's present knowledge of supplier's current prices, current overseas exchange rate, insurance, freight, the prevailing customs tariff, shipping, wharfage, stacking and customs agency costs. In the event of a change to any of these a commensurate change in price to that quoted may be charged.

d. Duration. Unless otherwise stated in writing, quoted prices shall not stand for more than 30 days.

e. Writing. The Company will not be bound by quotes not evidenced in writing.

### 12. Retention of Title

a. Until any and all goods sold by the Company to the customer are paid in full, their ownership shall remain with the Company but the risk shall pass to the customer on delivery to the customer or into the customer's custody (whichever is sooner) and the customer should appropriately insure.

b. Until any goods are paid in full, the Company authorise the customer to use, fix, install or sell the goods on but as agent for the Company. The customer shall however not represent to any third parties that it is any way acting for the Company and the Company will not be bound by any contracts with third parties to which the customer is a party.

c. The customer hereby irrevocably grants the Company permission to enter premises on which any of the Company's goods are kept in the event that the customer defaults or commits any act of bankruptcy, or insolvency, or a receiver or a receiver and manager is appointed, or the customer goes into liquidation, and retake possession of invoiced goods as a result of non-payment and this is without prejudice to any other rights of the Company.

d. In the event that the Company retakes possession of any goods then the Company may resell such goods with or without the consent of the customer.

### 13. Intellectual Property

a. The Customer acknowledges that:

i. All trademarks, copyright and other intellectual property rights (Intellectual Property) embodied in or in connection with the products, and any related documentation, or parts are the sole property of the Company or its suppliers; and

ii. All intellectual property of the Company or its suppliers may only be used by the Customer with the consent of the Company or its suppliers.

b. The Customer must not, without prior written consent of the Company, register or use any trademarks, trade name, domain name, trading style or commercial designation or design used by the Company or its suppliers in connection with the product.

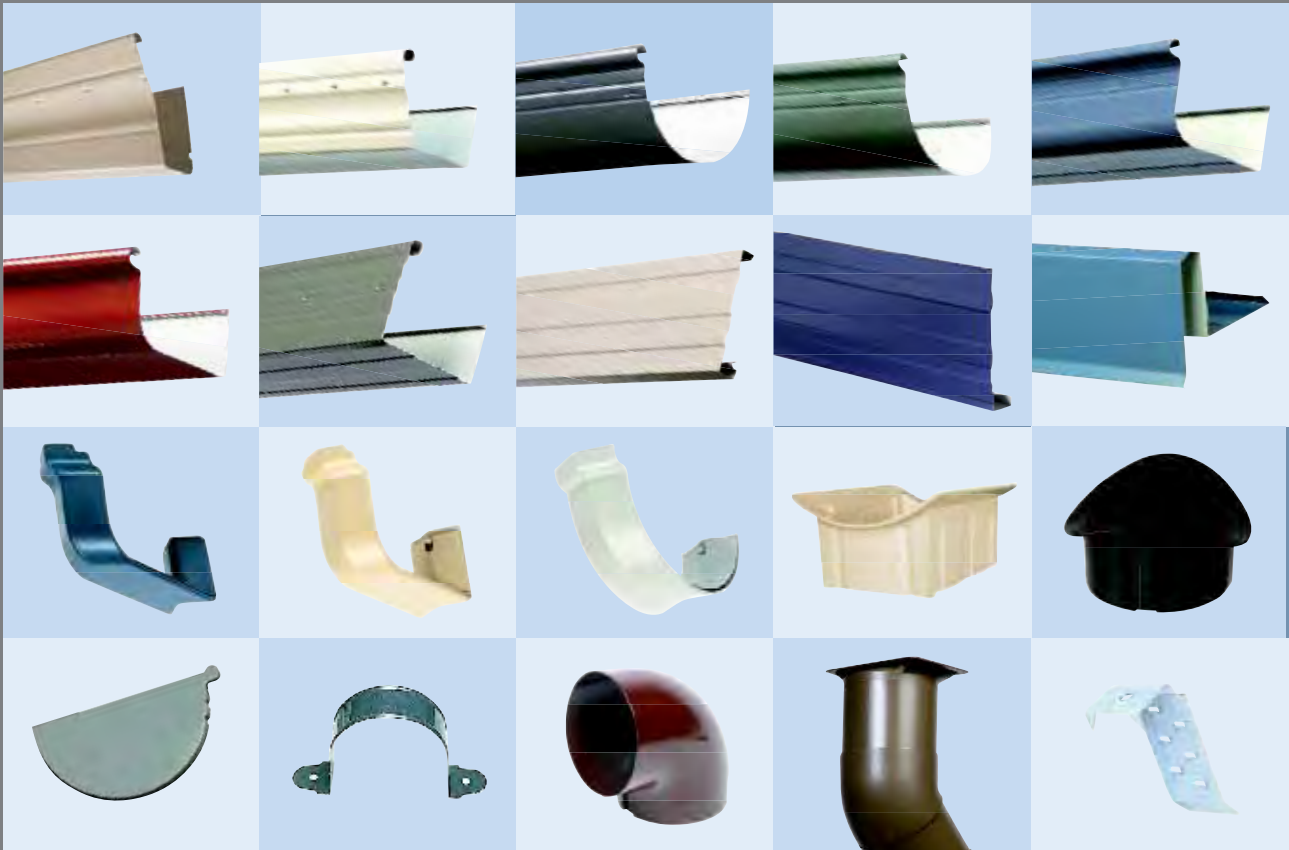

ABN 49 001 885 276

**NSW**

69 Boundary Rd  
Mortdale NSW 2223

Phone: (02) 9584 4777  
Gutter Fax: (02) 9584 4799  
Plumbing Fax: (02) 9584 4755  
Email: sales@acegutters.com.au

**NEWCASTLE AREA**

Phone: (02) 4948 6611  
(02) 4325 5200  
Fax: (02) 4948 9543  
Diverted to Sydney Toll Free

**ACT**

Phone: 02 6140 4925

[www.acegutters.com.au](http://www.acegutters.com.au)

Disclaimer: While Ace Gutters has taken all reasonable care in preparing this book, Ace Gutters takes no responsibility for loss resulting from relying on its content. Customers should make their own enquiries as to whether any products described in this book are suitable for their intended use. Information in this book may change without notice.